

User's Manual

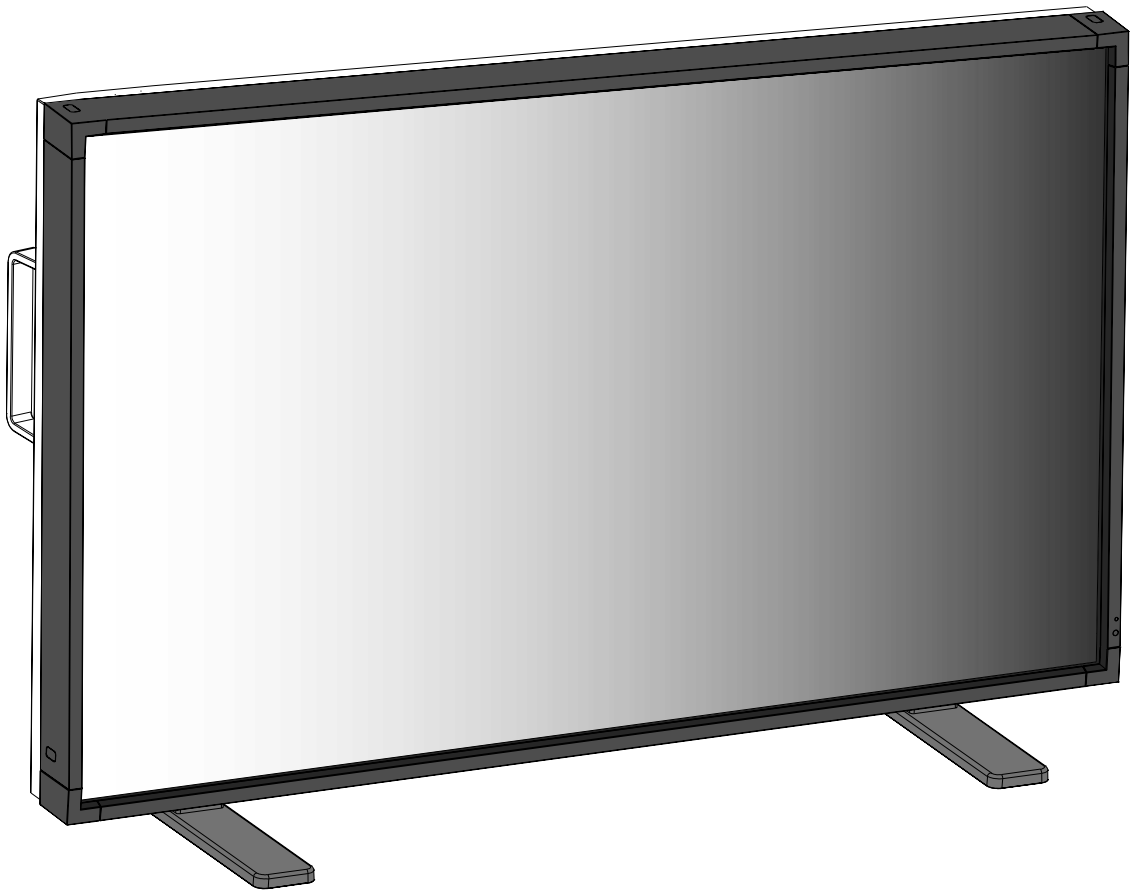

**MultiSync LCD4020**

**MultiSync LCD4620**

# Index

---

Declaration of conformity .....	English-1
Important Information .....	English-2
Warning, Caution .....	English-2
Declaration .....	English-2
Safety Precautions, Maintenance & Recommended Use .....	English-3
Contents .....	English-4
Parts Name and Functions .....	English-5
Control Panel .....	English-5
Terminal Panel .....	English-6
Wireless Remote Control .....	English-7
Operating Range for the Remote Control .....	English-8
Handling the remote control .....	English-8
Installation .....	English-9
Setup .....	English-12
Connections .....	English-14
Connecting a Personal Computer .....	English-14
Connect the LCD Monitor to a Personal Computer .....	English-14
Connecting to a Macintosh Computer .....	English-15
Connect the LCD Monitor to Macintosh .....	English-15
Connecting with Digital Interface Equipment .....	English-16
Connect the LCD Monitor to a Computer with a Digital Output .....	English-16
Connecting a DVD Player with component out .....	English-17
Connect the LCD Monitor to a DVD Player .....	English-17
Connecting a DVD Player with HDMI out .....	English-18
Connect the LCD Monitor to a DVD Player .....	English-18
Connecting a DVD Player with SCART out .....	English-18
Connect the LCD Monitor to a DVD Player .....	English-18
Connecting to a Stereo Amplifier .....	English-19
Connect the LCD Monitor to a Stereo Amplifier .....	English-19
Connecting to a TV .....	English-20
Basic Operation .....	English-21
Power ON and OFF Modes .....	English-21
Power Indicator .....	English-22
Using Power Management .....	English-22
Selecting a video source .....	English-22
Picture Size .....	English-22
Picture Mode .....	English-22
Information OSD .....	English-22
OSD (On-Screen-Display) Controls .....	English-23
PICTURE .....	English-24
ADJUST .....	English-24
AUDIO .....	English-25
SCHEDULE .....	English-25
PIP .....	English-26
OSD .....	English-26
MULTI DISPLAY .....	English-27
DISPLAY PROTECTION .....	English-27
ADVANCED OPTION .....	English-27
TV TUNER .....	English-29
Controlling the LCD monitor via RS-232C Remote Control .....	English-32
Features .....	English-34
Troubleshooting .....	English-35
Specifications - LCD4020 .....	English-36
Specifications - LCD4620 .....	English-37
Pin Assignment .....	English-38
Manufacturer's Recycling and Energy Information .....	English-39

## DECLARATION OF CONFORMITY

This device complies with Part 15 of FCC Rules. Operation is subject to the following two conditions. (1) This device may not cause harmful interference, and (2) this device must accept any interference received, including interference that may cause undesired operation.

<b>U.S. Responsible Party:</b>	<b>NEC Display Solutions of America, Inc.</b>
<b>Address:</b>	<b>500 Park Boulevard, Suite 1100 Itasca, Illinois 60143</b>
<b>Tel. No.:</b>	<b>(630) 467-3000</b>

Type of Product: Computer Monitor  
 Equipment Classification: Class B Peripheral  
 Model: MultiSync LCD4020 (L406T6)/MultiSync LCD4620 (L466T7)



*We hereby declare that the equipment specified above  
conforms to the technical standards as specified in the FCC Rules.*

Windows is a registered trademark of Microsoft Corporation. NEC is a registered trademark of NEC Corporation. OmniColor is a registered trademark of NEC Display Solutions Europe GmbH in the countries of EU and Switzerland. All other brands and product names are trademarks or registered trademarks of their respective owners.

### Canadian Department of Communications Compliance Statement

DOC: This Class B digital apparatus meets all requirements of the Canadian Interference-Causing Equipment Regulations.

C-UL: Bears the C-UL Mark and is in compliance with Canadian Safety Regulations according to CAN/CSA C22.2 No. 60950-1.

### FCC Information

- Use the attached specified cables with the MultiSync LCD4020 (L406T6)/MultiSync LCD4620 (L466T7) colour monitor so as not to interfere with radio and television reception.
  - Please use the supplied power cord or equivalent to ensure FCC compliance.
  - Please use the supplied shielded video signal cable, Mini D-SUB 15 pin to Mini D-SUB 15 pin.
- This equipment has been tested and found to comply with the limits for a Class B digital device, pursuant to part 15 of the FCC Rules. These limits are designed to provide reasonable protection against harmful interference in a residential installation. This equipment generates, uses, and can radiate radio frequency energy, and, if not installed and used in accordance with the instructions, may cause harmful interference to radio communications. However, there is no guarantee that interference will not occur in a particular installation. If this equipment does cause harmful interference to radio or television reception, which can be determined by turning the equipment off and on, the user is encouraged to try to correct the interference by one or more of the following measures:
  - Reorient or relocate the receiving antenna.
  - Increase the separation between the equipment and receiver.
  - Connect the equipment into an outlet on a circuit different from that to which the receiver is connected.
  - Consult your dealer or an experienced radio/TV technician for help.

If necessary, the user should contact the dealer or an experienced radio/television technician for additional suggestions. The user may find the following booklet, prepared by the Federal Communications Commission, helpful: "How to Identify and Resolve Radio-TV Interference Problems." This booklet is available from the U.S. Government Printing Office, Washington, D.C., 20402, Stock No. 004-000-00345-4.

The product you purchased may not have this feature.

LCD4020-AV, LCD4020-ATV, LCD4620-AV, LCD4620-ATV only



HDMI, the HDMI logo and High-Definition Multimedia Interface are trademarks or registered trademarks of HDMI Licensing LLC.

# Important Information



## WARNING



TO PREVENT FIRE OR SHOCK HAZARDS, DO NOT EXPOSE THIS UNIT TO RAIN OR MOISTURE. ALSO, DO NOT USE THIS UNIT'S POLARIZED PLUG WITH AN EXTENSION CORD RECEPTACLE OR OTHER OUTLETS UNLESS THE PRONGS CAN BE FULLY INSERTED.

REFRAIN FROM OPENING THE CABINET AS THERE ARE HIGH VOLTAGE COMPONENTS INSIDE. REFER SERVICING TO QUALIFIED SERVICE PERSONNEL.



## CAUTION



**CAUTION:** TO REDUCE THE RISK OF ELECTRIC SHOCK, MAKE SURE POWER CORD IS UNPLUGGED FROM WALL SOCKET. TO FULLY DISENGAGE THE POWER TO THE UNIT, PLEASE DISCONNECT THE POWER CORD FROM THE AC OUTLET. DO NOT REMOVE COVER (OR BACK). NO USER SERVICEABLE PARTS INSIDE. REFER SERVICING TO QUALIFIED SERVICE PERSONNEL.



This symbol warns user that uninsulated voltage within the unit may have sufficient magnitude to cause electric shock. Therefore, it is dangerous to make any kind of contact with any part inside this unit.



This symbol alerts the user that important literature concerning the operation and maintenance of this unit has been included. Therefore, it should be read carefully in order to avoid any problems.

# Declaration

## Declaration of the Manufacturer

We hereby certify that the colour monitor MultiSync LCD4020 (L406T6)/MultiSync LCD4620 (L466T7) is in compliance with

Council Directive 73/23/EEC:  
– EN 60950-1

Council Directive 89/336/EEC:  
– EN 55022  
– EN 61000-3-2  
– EN 61000-3-3  
– EN 55024

and marked with



NEC Display Solutions, Ltd.  
4-13-23, Shibaura,  
Minato-Ku  
Tokyo 108-0023, Japan

## Disposing of your old NEC product

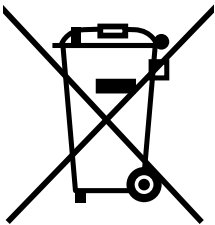

### Within the European Union

EU-wide legislation, as implemented in each Member State, requires that waste electrical and electronic products carrying the mark (left) must be disposed of separately from normal household waste. This includes monitors and electrical accessories, such as signal cables or power cords. When you need to dispose of your NEC display products, please follow the guidance of your local authority, or ask the shop where you purchased the product, or if applicable, follow any agreements made between yourself and NEC.

The mark on electrical and electronic products only applies to the current European Union Member States.

### Outside the European Union

If you wish to dispose of used electrical and electronic products outside the European Union, please contact your local authority so as to comply with the correct disposal method.

# Safety Precautions, Maintenance & Recommended Use

FOR OPTIMUM PERFORMANCE, PLEASE NOTE THE FOLLOWING WHEN SETTING UP AND USING THE MULTI-FUNCTION MONITOR:

- **DO NOT OPEN THE MONITOR.** There are no user serviceable parts inside and opening or removing covers may expose you to dangerous shock hazards or other risks. Refer all servicing to qualified service personnel.
- Do not spill any liquids into the cabinet or use your monitor near water.
- Do not insert objects of any kind into the cabinet slots, as they may touch dangerous voltage points, which can be harmful or fatal or may cause electric shock, fire or equipment failure.
- Do not place any heavy objects on the power cord. Damage to the cord may cause shock or fire.
- Do not place this product on a sloping or unstable cart, stand or table, as the monitor may fall, causing serious damage to the monitor.
- When operating the MultiSync monitor with its AC 220-240V power supply in Europe, use a power supply cord provided with the monitor.
- In UK, use a BS-approved power cord with molded plug having a black (13A) fuse installed for use with this monitor. If a power cord is not supplied with this monitor, please contact your supplier.
- When operating the MultiSync monitor with a 220-240V AC power source in Australia, use the power cord provided with the monitor. If a power cord is not supplied with this equipment, please contact your supplier.
- For all other cases, use a power cord that matches the AC voltage of the power outlet and has been approved by and complies with the safety standard of your particular country.
- Do not place any objects onto the monitor and do not use the monitor outdoors.
- The inside of the fluorescent tube located within the LCD monitor contains mercury. Please follow the bylaws or rules of your municipality to dispose of the tube properly.
- Do not bend, crimp or otherwise damage the power cord.
- If glass is broken, handle with care.
- Do not cover vent on monitor.
- Do not use monitor in high temperature, humid, dusty, or oily areas.
- If monitor or glass is broken, do not come in contact with the liquid crystal and handle with care.
- Allow adequate ventilation around the monitor, so that heat can properly dissipate. Do not block ventilated openings or place the monitor near a radiator or other heat sources. Do not put anything on top of the monitor.
- The power cable connector is the primary means of detaching the system from the power supply. The monitor should be installed close to a power outlet, which is easily accessible.
- Handle with care when transporting. Save packaging for transporting.
- Do not hold the display by the bezel when moving or shifting the display.
- Please clean the holes of back cabinet to reject dirt and dust at least once a year because of set reliability.
- If using the cooling fan continuously, it's recommended to wipe holes a minimum of once a month.

Immediately unplug your monitor from the wall outlet and refer servicing to qualified service personnel under the following conditions:

- When the power supply cord or plug is damaged.
- If liquid has been spilled, or objects have fallen into the monitor.
- If the monitor has been exposed to rain or water.
- If the monitor has been dropped or the cabinet damaged.
- If the monitor does not operate normally by following operating instructions.

## Recommended Use

- For optimum performance, allow 20 minutes for warm-up.
- Rest your eyes periodically by focusing on an object at least 5 feet away. Blink often.
- Position the monitor at a 90° angle to windows and other light sources to minimize glare and reflections.
- Clean the LCD monitor surface with a lint-free, non-abrasive cloth. Avoid using any cleaning solution or glass cleaner!
- Adjust the monitor's brightness, contrast and sharpness controls to enhance readability.
- Avoid displaying fixed patterns on the monitor for long periods of time to avoid image persistence (after image effects).
- Get regular eye checkups.

## Ergonomics

To realize the maximum ergonomic benefits, we recommend the following:

- Use the preset Size and Position controls with standard signals.
- Use the preset Colour Setting.
- Use non-interlaced signals.
- Do not use primary colour blue on a dark background, as it is difficult to see and may produce eye fatigue due to insufficient contrast.

## Cleaning the LCD Panel

- When the liquid crystal panel is stained with dust or dirt, please wipe with soft cloth gently.
- Please do not rub the LCD panel with hard material.
- Please do not apply pressure to the LCD surface.
- Please do not use OA cleaner it will cause deterioration or discolor on the LCD surface.

## Cleaning the Cabinet

- Unplug the power supply
- Gently wipe the cabinet with a soft cloth
- To clean the cabinet, dampen the cloth with a neutral detergent and water, wipe the cabinet and follow with a dry cloth.

**NOTE:** The surface of the cabinet is composed of many types of plastic. DO NOT clean with benzene thinner, alkaline detergent, alcoholic system detergent, glass cleaner, wax, polish cleaner, soap powder, or insecticide. Rubber or vinyl should not be in contact with the cabinet for an extended period of time. These types of fluids and materials can cause the paint to deteriorate, crack or peel.

# Contents

Your new MultiSync LCD4020/MultiSync LCD4620 monitor box\* should contain the following:

- LCD monitor
- Power Cord
- Video Signal Cable
- User's Manual
- Wireless Remote Control and AA Batteries
- Cable Cover
- Clamp x 3
- Screw (M4 x 10) x 9
- CD-ROM
- Stand x 2
- Thumbscrew for stand x 2

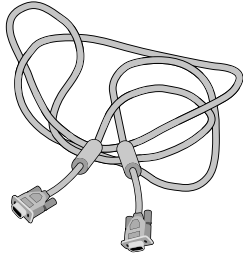

Video Signal Cable  
(Mini D-SUB 15 pin to  
Mini D-SUB 15 pin)

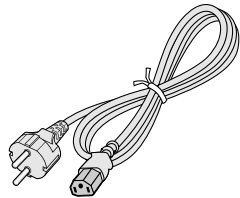

Power Cord

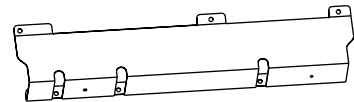
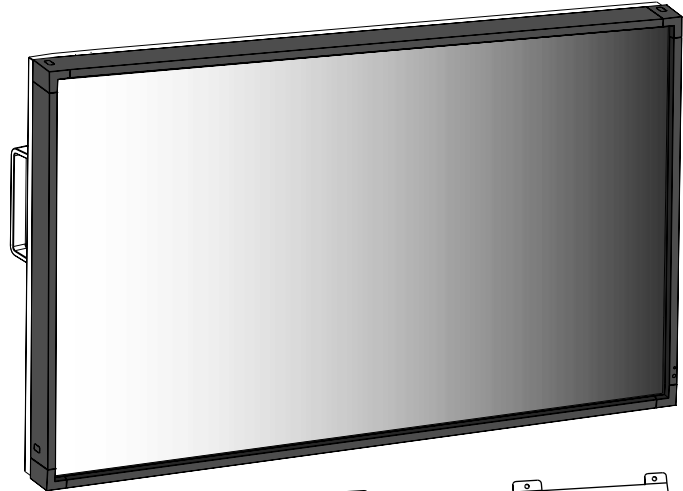

Cable Cover

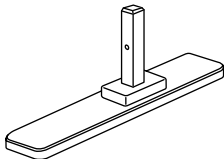

Stand x 2



Screw (M4 x 10) x 9



Clamp x 3



Thumbscrew for stand x 2

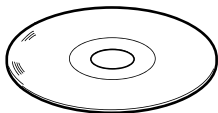

CD-ROM



User's Manual

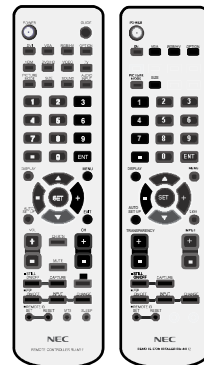

Wireless Remote Control  
and AA Batteries  
(The product you purchased has one  
of these remote controls)

- \* Install the stands at the time of unpacking if the display will be used with the stand.
- \* Remember to save your original box and packing material to transport or ship the monitor.

The following components are prepared as option.

- External Speaker Unit

# Parts Name and Functions

## Control Panel

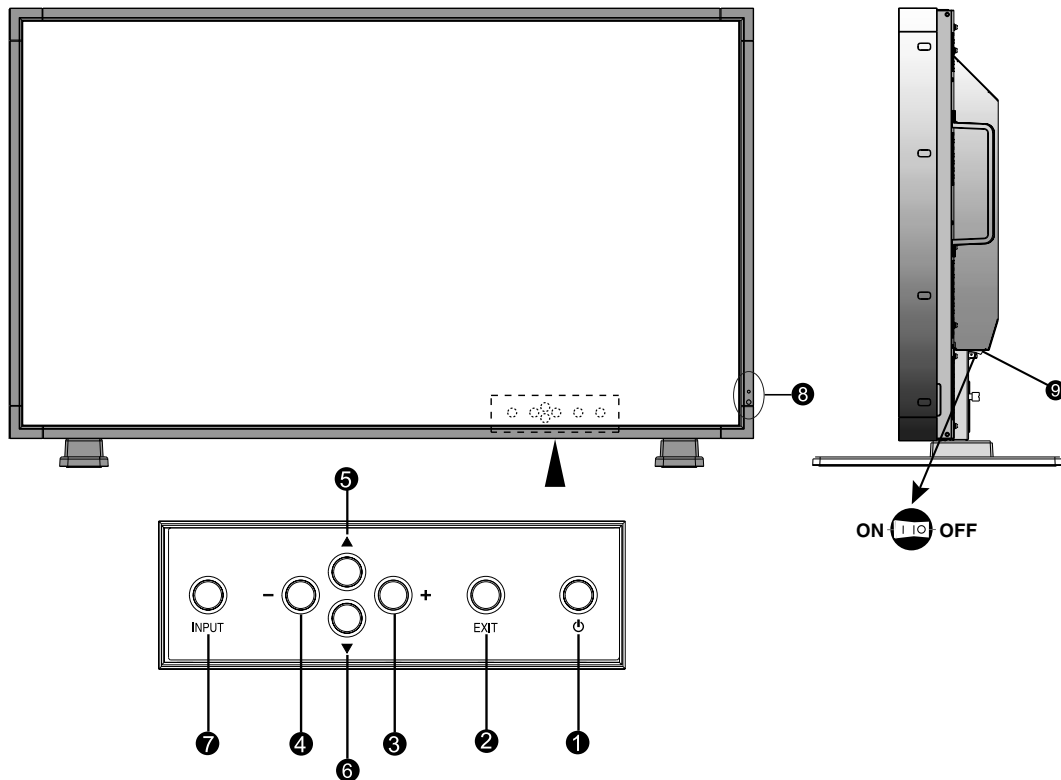

### 1 POWER button (⏻)

Switches the power on/off. See also page 21.

### 2 EXIT button

Activates the OSD menu when the OSD menu is turned-off. Acts as EXIT button to move to previous menu with OSD menu.

### 3 PLUS (+) button

Acts as (+) button to increase the adjustment with OSD menu. Increases the audio output level when the OSD menu is turned off.

### 4 MINUS (-) button

Acts as (-) button to decrease the adjustment with OSD menu. Decreases the audio output level when the OSD menu is turned off.

### 5 UP (▲) button

Activates the OSD menu when the OSD menu is turned-off. Acts as ▲ button to move the highlighted area up to select the adjustment with OSD menu.

### 6 DOWN (▼) button

Activates the OSD menu when the OSD menu is turned-off. Acts as ▼ button to move the highlighted area down to select the adjustment with OSD menu.

### 7 INPUT button

Acts as SET button within OSD menu. (Toggle switches between [DVI], [VGA], [RGB/HV], [HDMI], [DVD/HD], [VIDEO], [S-VIDEO] or [TV]). [S-VIDEO] is enabled by selecting the "SEPARATE" mode in the OSD or by having the "S-VIDEO" cable connected with the "S-VIDEO" signal present and selecting "PRIORITY" MODE. See page 28.

### 8 Remote control sensor and Power Indicator

Receives the signal from the remote control (when using the wireless remote control). See also page 8. Glows green when the LCD monitor is in active\*. Glows red when the LCD is in POWER OFF (ECO standby) mode. Glows Amber when the LCD is in POWER OFF (standby). Amber blinks when the monitor is in Power Save Mode. Green and Amber blink alternately while in Power Standby with the "SCHEDULE SETTINGS" function enabled. When a component failure is detected within the monitor, the indicator will blink red.

\* If "OFF" is selected in "POWER INDICATOR" (see page 27), LED will not light when the LCD monitor is in active mode.

### 9 Main Power Switch

On/off Switch to turn main power on/off.

### Control Key Lock Mode

This control completely locks out access to all Control Key functions. To activate the control key lock function, press both of ▼ and ▲ and hold down simultaneously for more than 3 seconds. To resume back to user mode, press both of ▼ and ▲ and hold simultaneously for more than 3 seconds.

# Terminal Panel

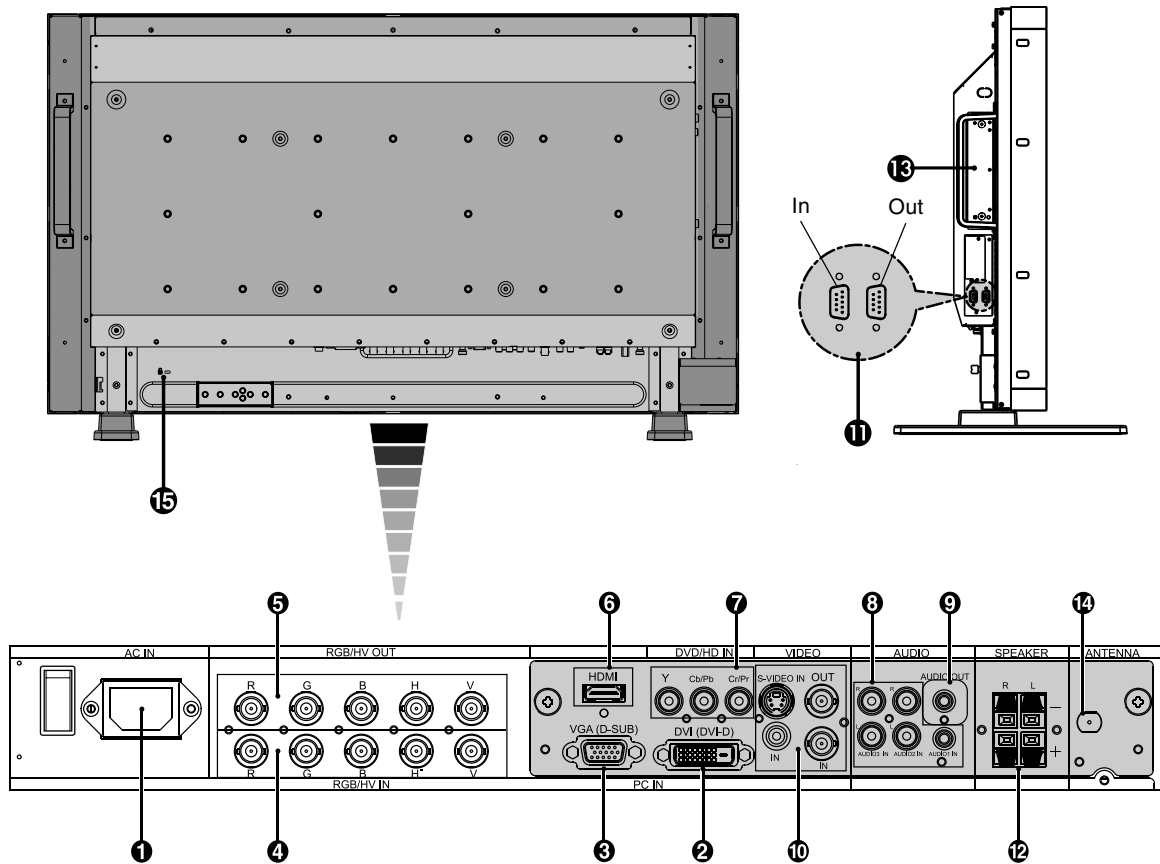

## 1 AC IN connector

Connects with the supplied power cord.

## 2 DVI IN (DVI-D)

To input digital RGB signals from a computer or HDTV device having a digital RGB output.

\* This connector does not support analog input.

## 3 VGA IN (mini D-Sub 15 pin)

To input analog RGB signals from a personal computer or other RGB equipment.

## 4 RGB/HV IN [R, G, B, H, V] (BNC)

To input analog RGB signals or signals from other RGB equipment.  
This is also to connect equipment such as a DVD player, HDTV device and Set-Top-Box. A Sync-on-Green signal can be connected to the G connector.

## 5 RGB/HV OUT (BNC)

To outputs the signal from the RGB/HV IN connector to an input on a separate device.

## 6 HDMI connector\*

To input digital HDMI signals.

## 7 DVD/HD connector (RCA)\*

Connecting equipment such as a DVD player, HDTV device, or Set-Top-Box.

## 8 AUDIO IN 1, 2, 3\*

To input audio signal from external equipment such as a computer, VCR or DVD player.

## 9 AUDIO OUT\*

To output the audio signal from the AUDIO IN 1, 2, 3, HDMI, and TV jack to an external device (stereo receiver, amplifier, etc.).

## 10 VIDEO INPUT/OUTPUT Connector\*

**VIDEO IN connector (BNC and RCA):** To input a composite video signal. BNC and RCA connectors are not available at the same time (Use only one input).

**VIDEO OUT connector (BNC):** To output the composite video signal from the VIDEO IN connector.

**S-VIDEO IN connector (Mini DIN 4 pin):** To input the S-video (Y/C separate signal). See page 28, S-VIDEO MODE SETTING.

## 11 EXTERNAL CONTROL (D-Sub 9 pin)

**IN connector:** Connect RS-232C input to external equipment such as a PC in order to control RS-232C functions.

**Out connector:** Connect RS-232C output. To connect to multiple MultiSync monitors via RS-232C daisy Chain.

## 12 EXTERNAL SPEAKER TERMINAL\*

To output the audio signal from AUDIO 1, 2, 3, HDMI and TV jack.

**Note:** This speaker terminal is for 15W + 15W (8 ohm) speaker.

## 13 Option board slot

Slot for board accessories. Please contact your supplier for detail information.

## 14 Antenna Input\*

Connects to antenna or to TV signal.

## 15 Kensington Lock

For security and theft prevention.

\*: The product you purchased may not have this feature.



## Wireless Remote Control

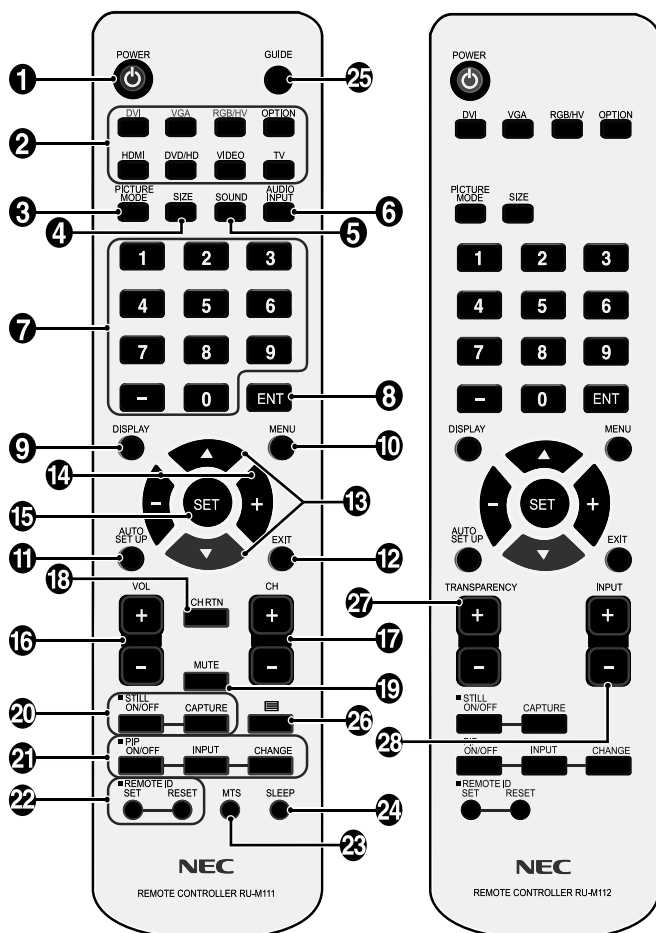

(The product you purchased has one of these remote controls)

### 1 POWER button

Switches the power on/off.

### 2 INPUT button\*

Selects which input signal, [DVI], [VGA], [RGB/HV], [HDMI], [DVD/HD], [VIDEO], [TV] or [S-VIDEO].  
[S-VIDEO] is enabled by selecting the "SEPARATE" mode in the OSD or by having the "S-VIDEO" cable connected with the "S-VIDEO" signal present and selecting "PRIORITY" MODE. See page 28.

### 3 PICTURE MODE button

Selects from picture mode, [HIGHBRIGHT], [STANDARD], [sRGB], [CINEMA]. See page 22.

HIGHBRIGHT: for moving images such as DVD  
STANDARD: for images  
sRGB: for text based images  
CINEMA: for movies.

### 4 SIZE button

Selects picture size, [FULL], [NORMAL], [WIDE] and [ZOOM]. See page 22.

### 5 SOUND button\*

Artificial surround sound.

### 6 AUDIO INPUT button\*

Selects from input audio source [IN1], [IN2], [IN3], [HDMI], [TV].

### 7 KEYPAD

Press to set and change passwords, change channel and set REMOTE ID.

### 8 ENT button

Sets channels.

### 9 DISPLAY button

Turns on/off the information OSD. See page 22.

### 10 MENU button

Turns on/off the menu mode.

### 11 AUTO SETUP button

Enters auto setup menu. See page 24.

### 12 EXIT button

Turns to previous menu with OSD menu.

### 13 UP/DOWN button

Acts as ▲ ▼ button to move the highlighted area up or down to select the adjustment with OSD menu.  
Small screen which adjusted "PIP" mode moves up or down.

### 14 MINUS/PLUS (+/-) button

Increases or decreases the adjustment with OSD menu.  
Small screen which adjusted "PIP" mode moves left or right.

### 15 SET button

Makes selection.

### 16 VOLUME UP/DOWN button

Increases or decreases audio output level.

### 17 CH +/- button\*

Moves channel up or down.

### 18 CH RTN button\*

Returns to previous channel.

### 19 MUTE button\*

Turns on/off mute function.

### 20 STILL button

**ON/OFF button:** Activates/deactivates on/off still picture mode.

**STILL CAPTURE button:** Captures still picture.

### 21 PIP (Picture In Picture) button

**ON/OFF button:** Toggle switches between PIP, POP, side-by-side (aspect) and side-by-side (full). See page 26.

**INPUT button:** Selects the "picture in picture" input signal.  
**CHANGE button:** Replaces to the main picture and sub picture.

		Sub picture						
		DVI	VGA	RGB/HV	HDMI	DVD/HD	VIDEO	TV
Main picture	DVI	-	-	-	-	✓	✓	✓
	VGA	-	-	-	-	✓	✓	✓
	RGB/HV	-	-	-	-	✓	✓	✓
	HDMI	-	-	-	-	✓	✓	✓
	DVD/HD	✓	✓	✓	✓	-	✓	✓
	VIDEO	✓	✓	✓	✓	✓	-	-
	TV	✓	✓	✓	✓	✓	-	-

\*: The product you purchased may not have this feature.

**22 REMOTE ID button**

Activates REMOTE ID function.

**23 MTS button\***

Multichannel television sound.

**24 SLEEP button\***

Sets power off timer.

**25 GUIDE button\***

Use in TELETEXT mode. See page 20.

**26  button\***

TELETEXT controls. See page 20.

**27 TRANSPARENCY button\***

Determines the level of OSD transparency.

**28 INPUT button\***

Cycles through available inputs.

\*: The product you purchased may not have this feature.

## Operating Range for the Remote Control

Point the top of the remote control toward the LCD monitor's remote sensor during button operation.

Use the remote control within a distance of about 7 m/23 ft. from the front of the LCD monitor's remote control sensor and at a horizontal and vertical angle of within 30° within a distance of about 3.5 m/10 ft.

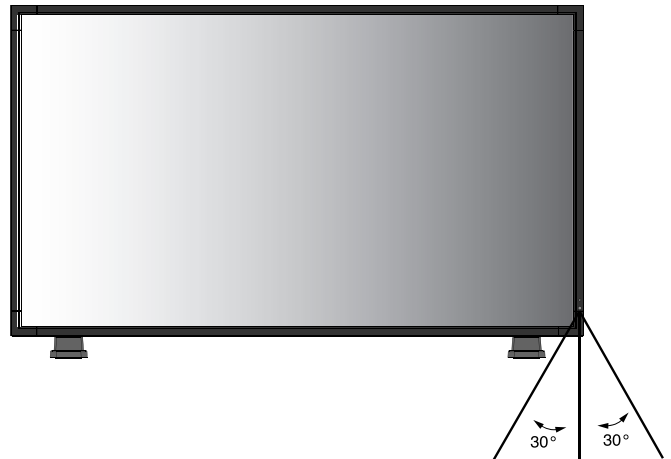

**Caution:** Important, the remote control system may not function when direct sunlight or strong illumination strikes the remote control sensor of the LCD monitor, or when there is an object in the path.

## Handling the remote control

- Do not subject to strong shock.
- Do not allow water or other liquid to splash the remote control. If the remote control gets wet, wipe it dry immediately.
- Avoid exposure to heat and steam.
- Other than to install the batteries, do not open the remote control.

# Installation

This device cannot be used or installed without the Tabletop Stand or other mounting accessory for support. For proper installation it is strongly recommended to use a trained, NEC authorized service person. Failure to follow NEC standard mounting procedures could result in damage to the equipment or injury to the user or installer. Product warranty does not cover damage caused by improper installation. Failure to follow these recommendations could result in voiding the warranty.

For further mounting information see page 9.

For Stand information see page 10~11.

## Mounting

DO NOT mount the monitor yourself. Please ask dealer. For proper installation it is strongly recommended to use a trained, qualified technician. Please inspect the location where the unit is to be mounted. Mounting on wall or ceiling is the customer's responsibility. Not all walls or ceilings are capable of supporting the weight of the unit. Product warranty does not cover damage caused by improper installation, remodeling, or natural disasters. Failure to comply with these recommendations could result in voiding the warranty.

DO NOT block ventilated openings with mounting accessories or other accessories.

### For NEC Qualified Personnel:

To insure safe installation, use two or more brackets to mount the unit. Mount the unit to at least two points on the installation location.

## Please note the following when mounting on wall or ceiling

- When using mounting accessories other than those that are NEC approved, they must comply with the VESA-compatible (FDMIv1) mounting method.
- NEC strongly recommends using size M6 screws (10mm + thickness of bracket in length). If using screws longer than 10mm, check the depth of the hole. (Recommended Fasten Force: 470 - 635N•cm) NEC recommends mounting interfaces that comply with UL1678 standard in North America.
- Prior to mounting, inspect the installation location to insure that it is strong enough to support the weight of the unit so that the unit will be safe from harm.
- Refer to the instructions included with the mounting equipment for detailed information.

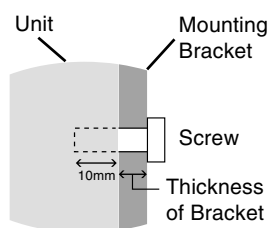

Screw length should equal depth of hole (10mm) + the thickness of mounting bracket.

## Orientation

- When using the display in the portrait position, the monitor should be rotated clockwise so that the left side is moved to the top and the LCD indicator light is on the bottom. This will allow for proper ventilation and will extend the lifetime of the monitor. Improper ventilation may shorten the lifetime of the monitor.

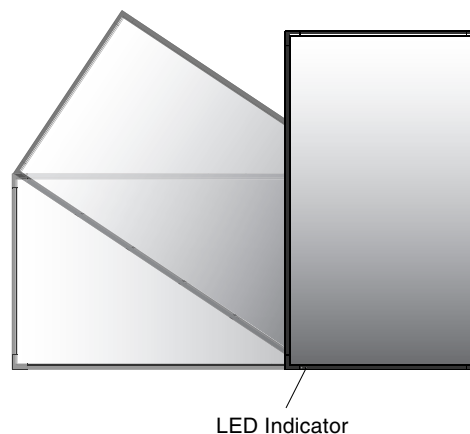

## Mounting location

- The ceiling and wall must be strong enough to support the monitor and mounting accessories.
- DO NOT install in locations where a door or gate can hit the unit.
- DO NOT install in areas where the unit will be subjected to strong vibrations and dust.
- DO NOT install near where the main power supply enters the building.
- Do not install in where people can easily grab and hang onto the unit or the mounting apparatus.
- When mounting in a recessed area, as in a wall, leave at least 4 inches (10cm) of space between the monitor and the wall for proper ventilation.
- Allow adequate ventilation or provide air conditioning around the monitor, so that heat can properly dissipate away from the unit and mounting apparatus.

## Mounting on ceiling

- Ensure that the ceiling is sturdy enough to support the weight of the unit and the mounting apparatus over time, against earthquakes, unexpected vibrations, and other external forces.
- Be sure the unit is mounted to a solid structure within the ceiling, such as a support beam. Secure the monitor using bolts, spring lock washers, washer and nut.
- DO NOT mount to areas that have no supporting internal structure. DO NOT use wood screws or anchor screws for mounting. DO NOT mount the unit to trim or to hanging fixtures.

## Maintenance

- Periodically check for loose screws, gaps, distortions, or other problems that may occur with the mounting apparatus. If a problem is detected, please refer to qualified personnel for service.
- Regularly check the mounting location for signs of damage or weakness that may occur over time.

# Attaching Mounting Accessories

The display is designed for use with the VESA mounting system.

## 1. Attach Mounting Accessories

Mounting accessories can be attached while the monitor is on the Tabletop Stand in the upright position (Figure 1). Be careful to avoid tipping monitor when attaching accessories. After accessories are attached, stand can be removed.

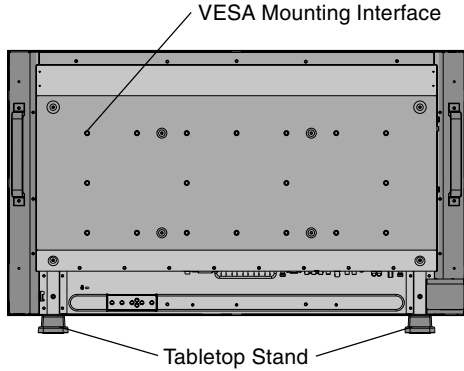
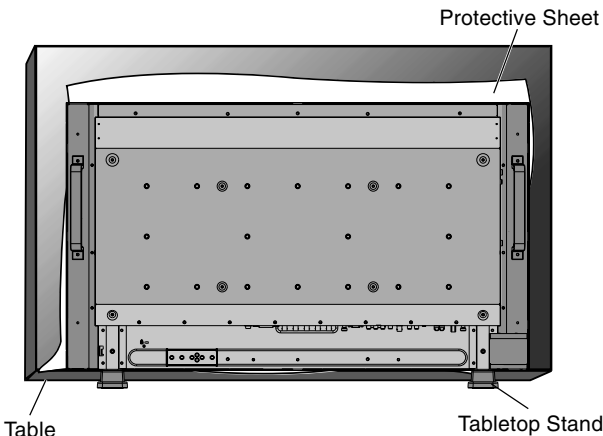

**Figure 1**

Mounting accessories can be attached with the monitor in the face down position. To avoid damaging the screen face, place the protective sheet on the table underneath the LCD (Figure 2). The protective sheet was wrapped around the LCD in the original packaging. Make sure there is nothing on the table that can damage the monitor.

When using mounting accessories other than NEC compliant and approved, they must comply with the VESA-compatible mounting method. NEC strongly recommends using screws M6 size and 10mm in length. If using screws longer than 10mm, check the depth of the hole. (Recommended Fasten Force: 470-635N•cm)

NEC recommends using mounting interface that comply with UL1678 standard in North America.



**Figure 2**

## 2. Installing and removing stand

**CAUTION:** Installing and removing the stand must be done by two or more people.

### How to install stand

1. Please turn monitor off.
2. Place stand onto monitor with the long ends of the feet in front of the monitor.
3. After inserting stand in guide block, fasten thumbscrews on both sides of the monitor.

### How to remove the stand

1. Spread the protective sheet on a flat surface, such as a desk.
2. Place monitor on the protective sheet.
3. Remove thumbscrews with a screwdriver or with your fingers and place them in a safe place for reuse.

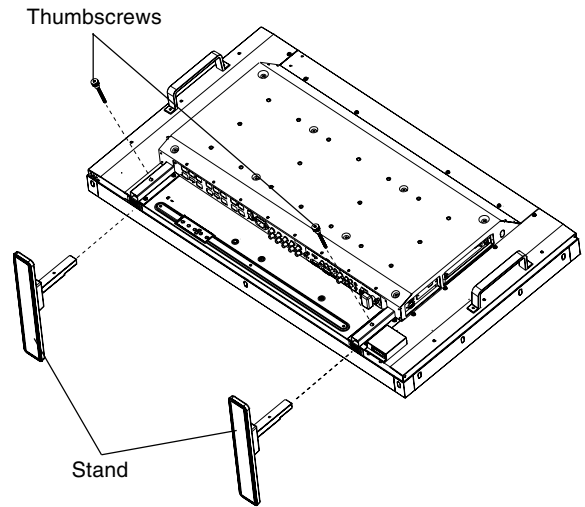

**NOTE:** Place stand onto monitor so that the long end of the feet are in the front.

**CAUTION:** Handle with care when mounting LCD monitor stand and avoid pinching your fingers.

## 3. Ventilation Requirements

When mounting in an enclosure or in a recessed area allow heat to disperse, leave space between surrounding the monitor and surrounding objects allow heat to disperse, as shown in Figure 3.

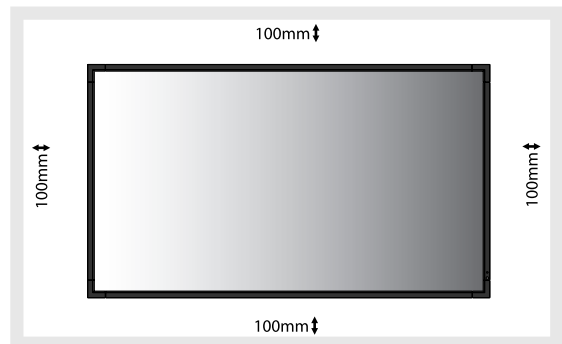

**Figure 3**

## 4. Prevent Tipping

When using the display with the Tabletop Stand fasten the LCD to a wall using a cord or chain that can support the weight of the monitor (approx. LCD4020: 31.1 Kg/LCD4620: 37.9 Kg) in order to prevent the monitor from falling. Fasten the cord or chain to the monitor using the provided clamp and screw.

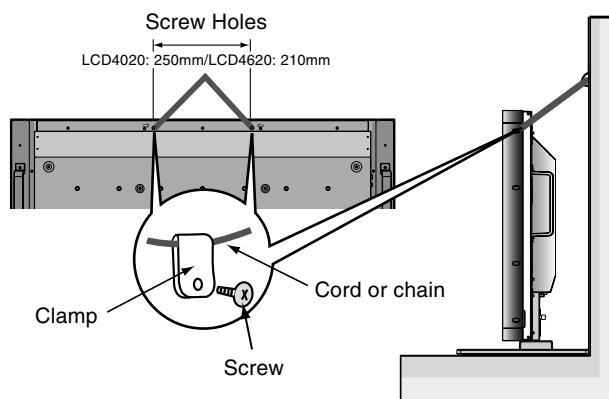

Before attaching the LCD monitor to the wall, make sure that the wall can support the weight of the monitor.

Be sure to remove the cord or chain from the wall before moving the LCD.

# Setup

## 1. Determine the installation location

**CAUTION:** Installing your LCD display must be done by a qualified technician. Contact your dealer for more information.

**CAUTION:** MOVING OR INSTALLING THE LCD MONITOR MUST BE DONE BY TWO OR MORE PEOPLE. Failure to follow this caution may result in injury if the LCD monitor falls.

**CAUTION:** Do not mount or operate the display upside down, face up, or face down.

**CAUTION:** This LCD has a temperature sensor and cooling fan. If the LCD becomes too hot, the cooling fan will turn on automatically. If the LCD becomes overheated while the cooling fan is running, the "Caution" menu will appear. If the "Caution" menu appears, discontinue use and allow the unit to cool. Using the cooling fan will reduce the likelihood of early circuit failure and may help reduce image degradation and "Image Persistence".

If the LCD is used in an enclosed area or if the LCD panel is covered with a protective screen, please check the inside temperature of the monitor by using the "HEAT STATUS" control in the OSD (see page 27). If the temperature is higher than the normal operating temperature, please turn the cooling fan to ON within the FAN CONTROL menu within the OSD (see page 27).

**IMPORTANT:** Lay the protective sheet, which was wrapped around the LCD monitor when it was packaged, beneath the LCD monitor so as not to scratch the panel.

## 2. Install the remote control batteries

The remote control is powered by two 1.5V AA batteries. To install or replace batteries:

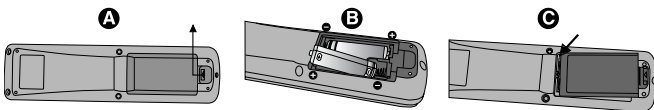

- Press and slide to open the cover.
- Align the batteries according to the (+) and (-) indications inside the case.
- Replace the cover.

**CAUTION:** Incorrect usage of batteries can result in leaks or bursting.

NEC recommends the following battery use:

- Place "AA" size batteries matching the (+) and (-) signs on each battery to the (+) and (-) signs of the battery compartment.
- Do not mix battery brands.
- Do not combine new and old batteries. This can shorten battery life or cause liquid leakage of batteries.
- Remove dead batteries immediately to prevent battery acid from leaking into the battery compartment.
- Do not touch exposed battery acid, it may injure skin.

**NOTE:** If you do not intend to use the Remote Control for a long period of time, remove the batteries.

## 3. Connect external equipment (See pages 14-20)

- To protect the external equipment; turn off the main power before making connections.
- Refer to your equipment user manual for further information.

## 4. Connect the supplied power cord

- The equipment should be installed close to an easily accessible power outlet.
- Please attach power cord to the LCD monitor by attaching the screw and clamp.
- Fully insert the prongs into the power outlet socket. A loose connection may cause image degradation.

**NOTE:** Please refer to "Safety Precautions and Maintenance" section of this manual for proper selection of AC power cord.

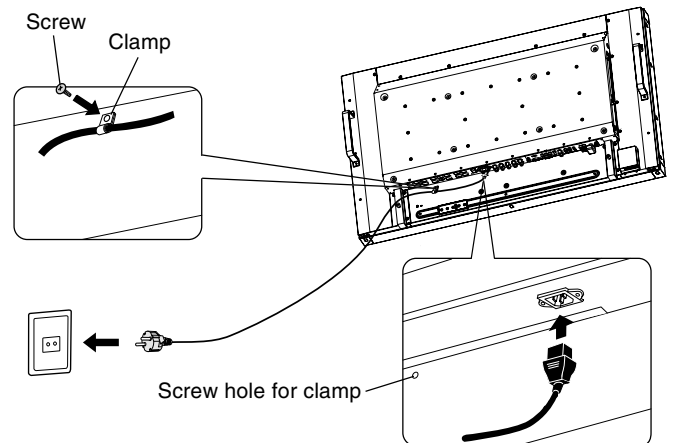

## 5. Attach the cable cover

- Remove the six screws (Figure 4).
- Use 6 of the M4 x 10 screws (included) to attach the cable cover (Figure 5).

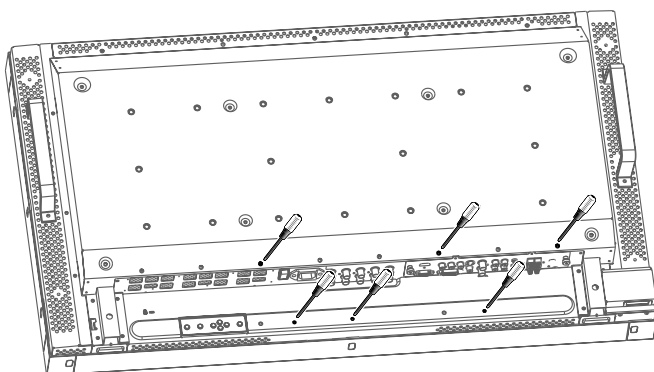

Figure 4

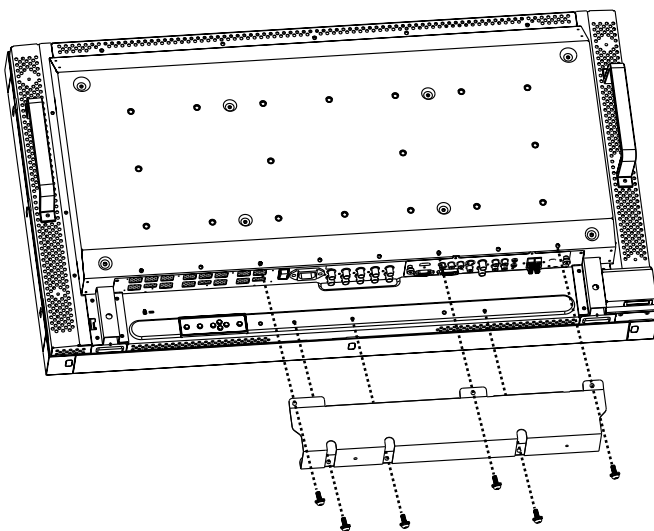

Figure 5

## 6. Switch on the power of all the attached external equipment

When connected with a computer, switch on the power of the computer first.

## 7. Operate the attached external equipment

Display the signal from the desired input source.

## 8. Adjust the sound

Make adjustments when adjustment of the volume is required.

## 9. Adjust the screen (See pages 24 and 25)

Make adjustments of the screen display position when necessary.

## 10. Adjust the image (See page 24)

Make adjustments such as brightness or contrast when required.

## 11. Recommended Adjustments

To reduce the risk of the “image persistence”, please adjust the following items based on the application being used: “SCREEN SAVER”, “SIDE BORDER COLOR” (See page 27) “DATE & TIME”, “SCHEDULE SETTINGS” (See page 25). It is recommended that the “FAN CONTROL” setting (See page 27) be turned to ON also.

# Connections

## Before making connections:

- \* First turn off the power of all the attached equipment and make connections.
- \* Refer to the user manual included with each separate piece of equipment.

## Connecting a Personal Computer

Connecting your computer to your LCD monitor will enable you to display your computer's screen image. Some video cards and pixel clock over 165MHz may not display an image correctly. Your LCD monitor displays proper image adjusting the factory preset timing signal automatically.

<Factory preset signal timing>

Resolution	Scanning frequency		Remarks
	Horizontal	Vertical	
640 x 480	31.5kHz	60Hz	
800 x 600	37.9kHz	60Hz	
1024 x 768	48.4kHz	60Hz	
1280 x 768	48kHz	60Hz	
1360 x 768	48kHz	60Hz	Recommended resolution
1280 x 1024	64kHz	60Hz	Compressed image
1600 x 1200	75kHz	60Hz	Compressed image

## Connect the LCD Monitor to a Personal Computer

- To connect the VGA IN connector (mini D-sub 15 pin) on the LCD monitor, use the supplied PC - Video RGB signal cable (mini D-sub 15 pin to mini D-sub 15 pin).
- To connect the RGB/HV connector (BNC) on the LCD monitor, use a signal cable which is available separately (mini D-sub 15 pin to BNC x 5). Select RGB/HV from the INPUT button.
- When connecting one or more LCD monitors, use the RGB OUT connector (BNC) (BNC INPUT only).
- The AUDIO IN 1, 2 and 3 can be used for audio input. For connection, select [IN1], [IN2] or [IN3] from the AUDIO INPUT button.

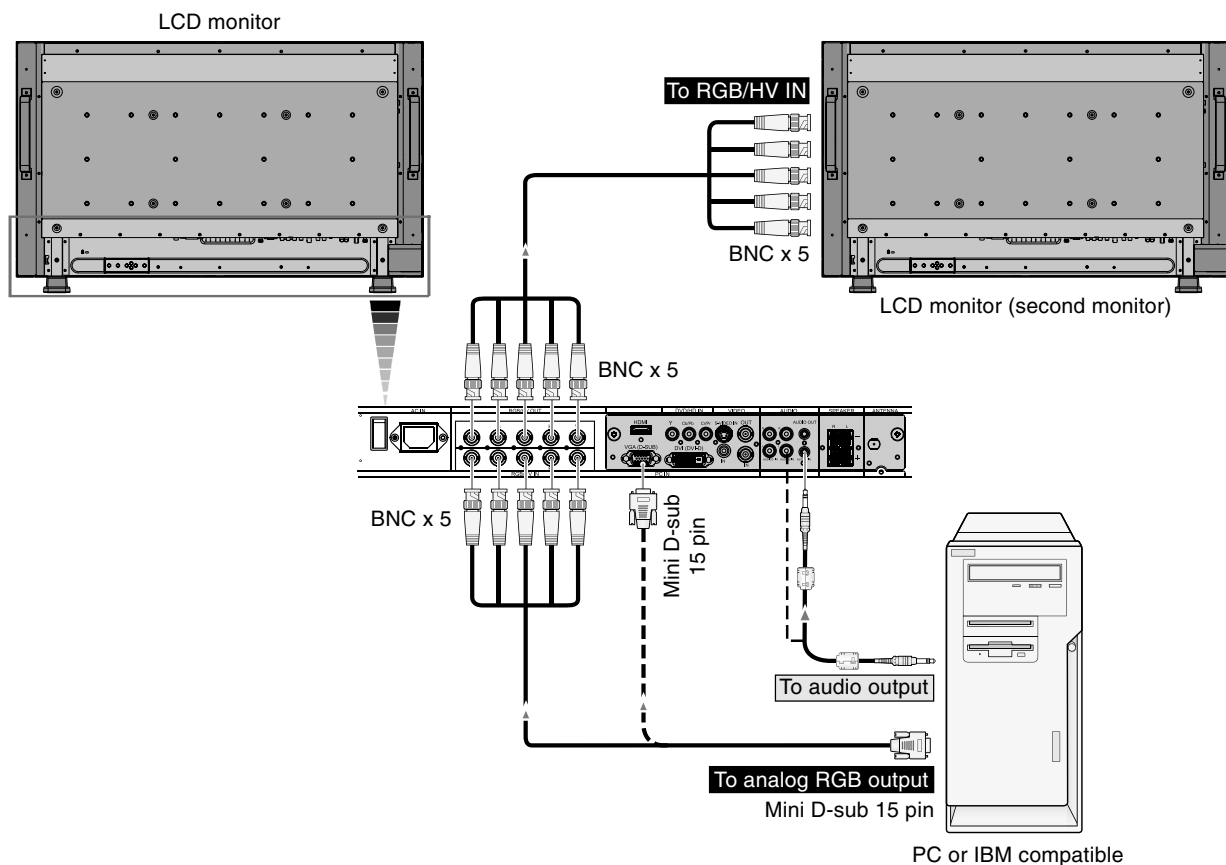



## Connecting to a Macintosh Computer

Connecting your Macintosh computer to your LCD monitor will enable you to display your computer's screen image. Some video cards or drivers may not display images correctly.

### Connect the LCD Monitor to Macintosh

- To connect the VGA IN connector (mini D-sub 15 pin) on the LCD monitor, use the supplied PC - Video RGB signal cable (mini D-sub 15 pin to mini D-sub 15 pin).
- To connect the RGB/HV IN connector (BNC) on the LCD monitor, use the signal cable available separately (mini D-sub 15 pin to BNC x 5) (BNC INPUT only).
- If you use with a Macintosh PowerBook, set "Mirroring" to Off.

Refer to your Macintosh's owner's manual for more information about your computer's video output requirements and any special identification or configuring your monitor's image and monitor may require.

- The AUDIO IN 1, 2 and 3 can be used for audio input. For connection, select [IN1], [IN2] or [IN3] from the AUDIO INPUT button.

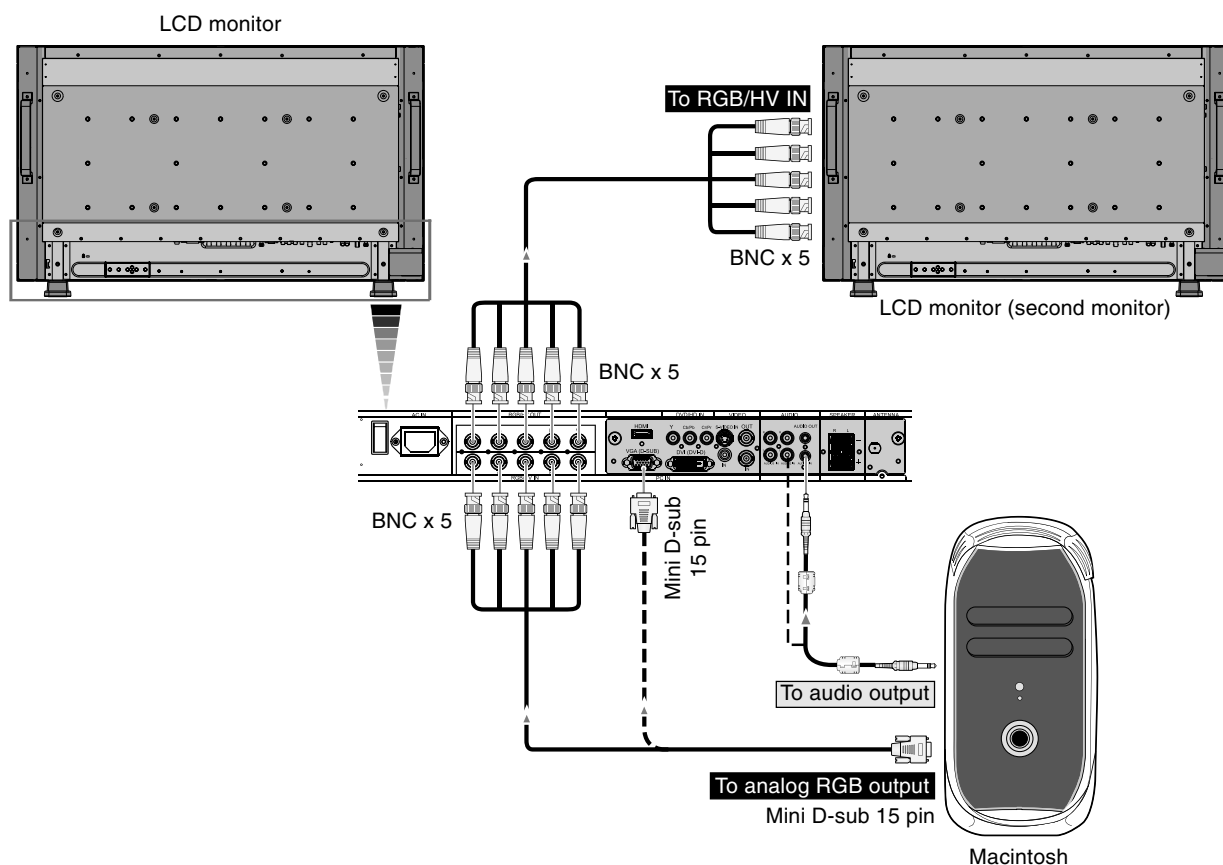

## Connecting with Digital Interface Equipment

Connections can be made with equipment that is equipped with a digital interface compliant with the DVI (Digital Visual Interface) standard.

### Connect the LCD Monitor to a Computer with a Digital Output

- The DVI IN connector also accepts a DVI-D cable.
- Input TMDS signals conforming to DVI standards.
- To maintain display quality, use a cable with a quality prescribed by DVI standards.
- The AUDIO IN 1, 2 and 3 can be used for audio input. For connection, select [IN1], [IN2] or [IN3] from the AUDIO INPUT button.
- Mode selection, see “DVI MODE” of page 28.

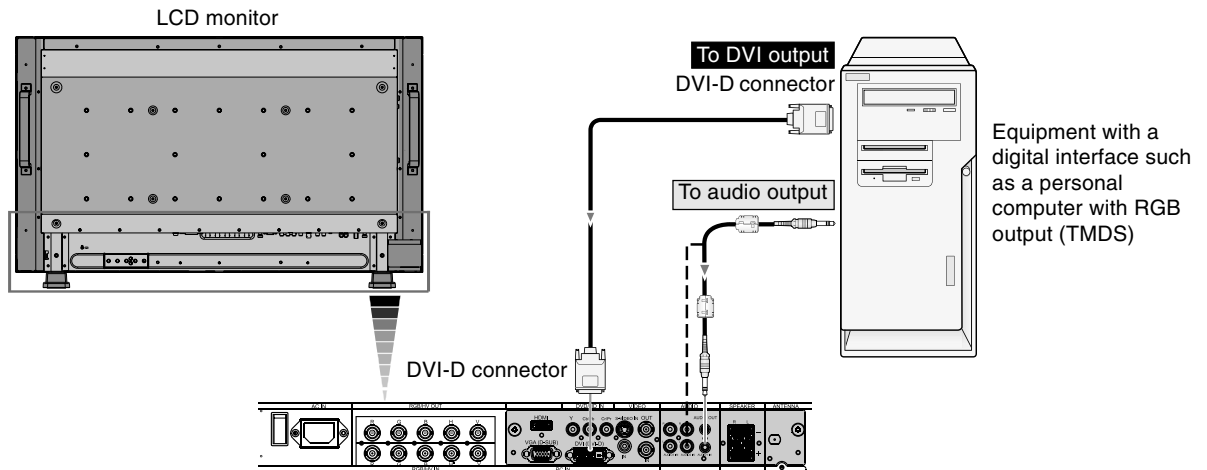

## Connecting a DVD Player with component out\*

Connecting your DVD player to your LCD monitor will enable you to display DVD video.

Refer to your DVD player user's manual for more information.

### Connect the LCD Monitor to a DVD Player

- To connect the DVD/HD IN connector (RCA) on the LCD monitor, use a separately available RCA connector cable. Some DVD players may have different connectors such as DVI-D connector. Select [DVI/HD] mode from the "DVI MODE" menu when you connect a DVI-D connector. Mode selection, see "DVI MODE" of page 28. The AUDIO IN 1, 2 and 3 (both RCA) can be used for audio input. For connection, select [IN1], [IN2] or [IN3] from the AUDIO INPUT button.

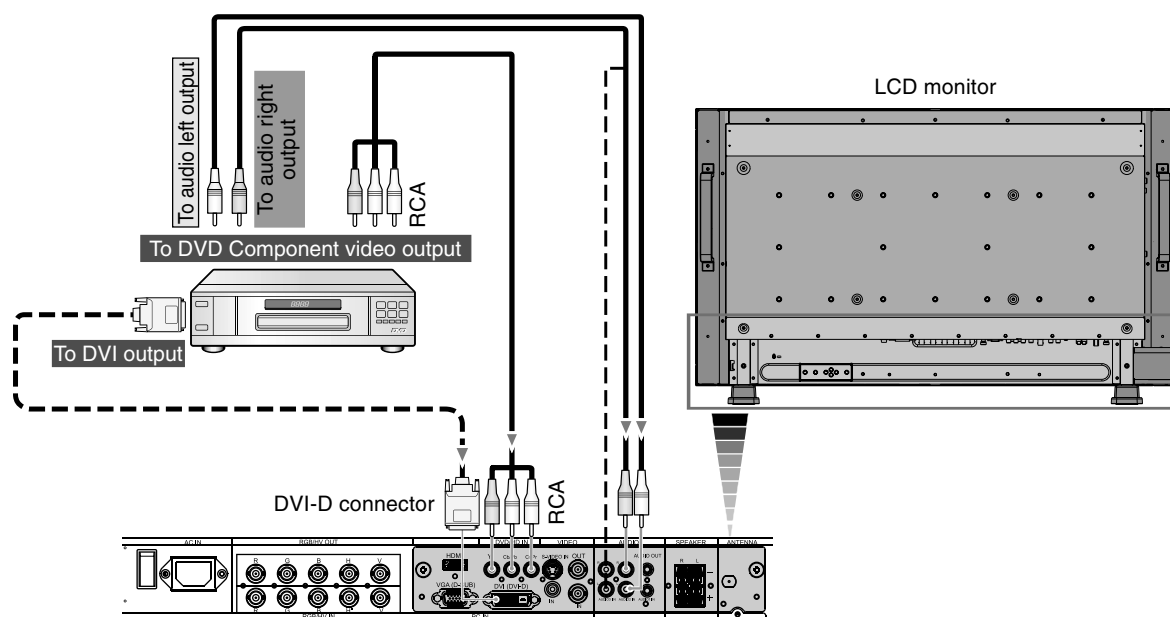

\*: The product you purchased may not have this feature.

## Connecting a DVD Player with HDMI out\*

Connecting your DVD player to your LCD monitor will enable you to display DVD video.

Refer to your DVD player user's manual for more information.

Select [HDMI] from the AUDIO INPUT button.

### Connect the LCD Monitor to a DVD Player

- Please use the HDMI cable with HDMI logo.
- You may need some seconds to show the signal.
- We do not support PC-DVI signal.

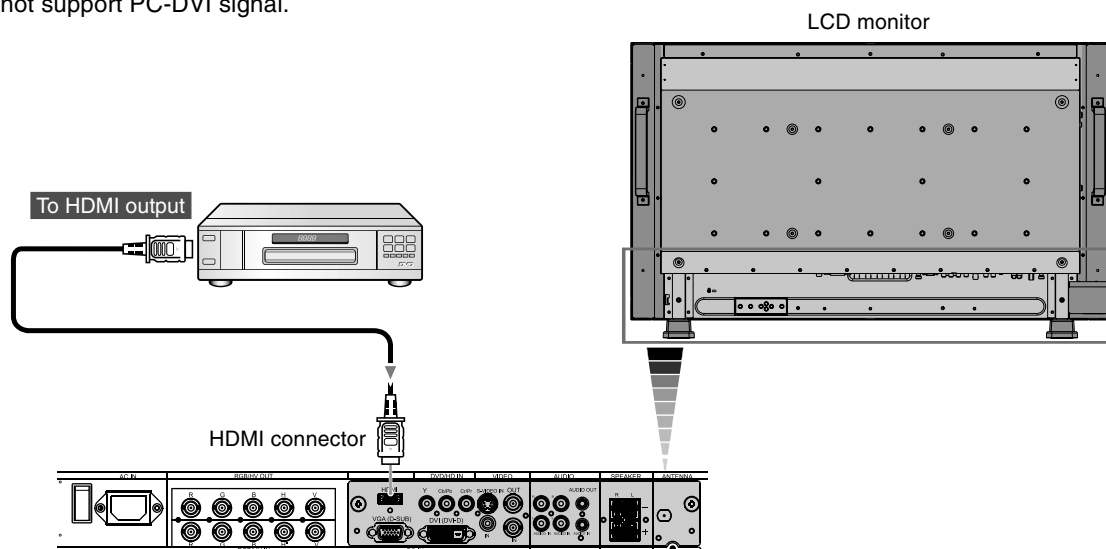

\*: The product you purchased may not have this feature.

## Connecting a DVD Player with SCART out\*

Connecting your DVD player to your LCD monitor will enable you to display SCART.

### Connect the LCD Monitor to a DVD Player

- To connect the DVD/HD IN connector (RCA) on the LCD monitor and connect the video (sync) and the Video In connector (RCA), use a separately available RCA connector cable.

Some DVD players may have different connectors such as DVI-D connector.

Select [ON] mode from the "SCART MODE" menu when you use a SCART connector. Mode selection, see "SCART" on page 28.

The AUDIO IN 1, 2 and 3 (both RCA) can be used for audio input. For connection, select [IN1], [IN2] or [IN3] from the AUDIO INPUT button.

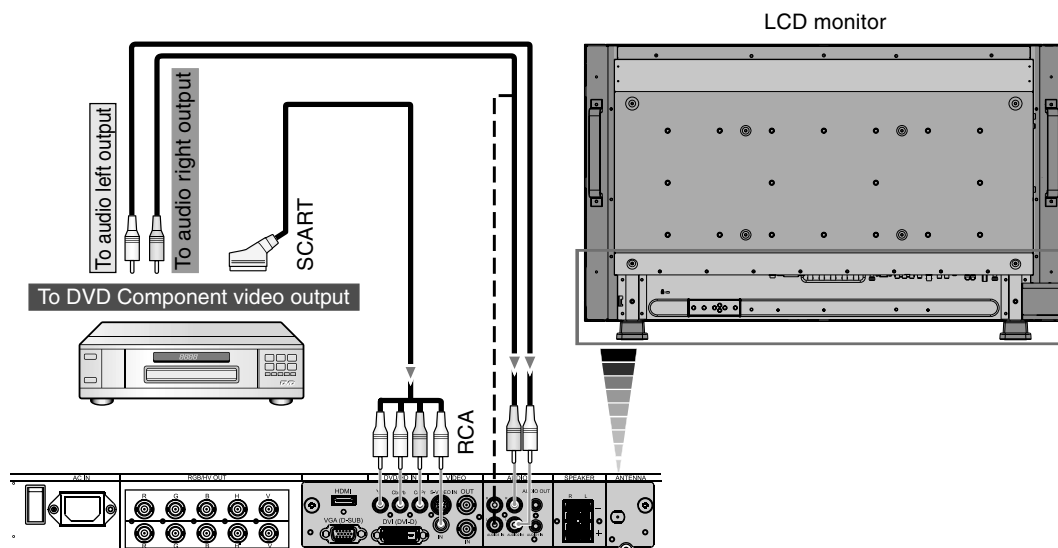

\*: The product you purchased may not have this feature.

## Connecting to a Stereo Amplifier\*

You can connect your stereo amplifier to your LCD monitor. Refer to your amplifier owner's manual for more information.

### Connect the LCD Monitor to a Stereo Amplifier

- Turn on the LCD monitor and the amplifier only after all connections have been made.
- Use a stereo Mini-RCA cable to connect the AUDIO OUT connector (Stereo Mini Jack) on the LCD monitor and the audio input on the amplifier.
- Do not reverse the audio left and right jacks.
- The AUDIO IN is used for audio input.
- The AUDIO OUT jack outputs sound from the selected Audio input.

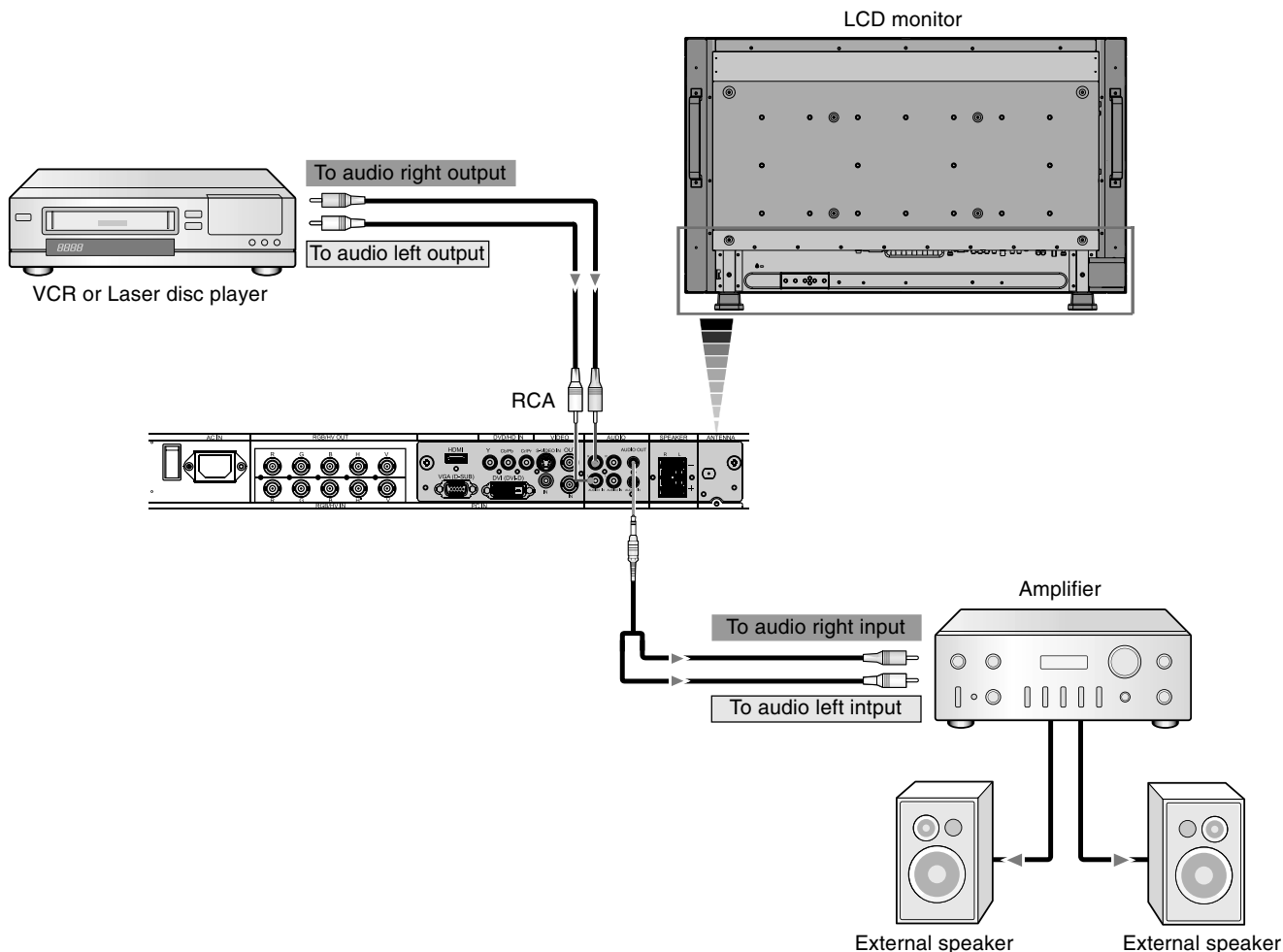

\*: The product you purchased may not have this feature.

# Connecting to a TV\*

## Precautions when connecting the antenna

- Use a coaxial cable which is free from interference. Avoid using a parallel flat wire as interference may occur, causing the reception to become unstable and noise to appear on the screen.
- Avoid using an indoor antenna as this may be affected by interference and poor reception.
- Cable distribution system should be grounded (earthed) in accordance with ANSI/NFPA 70, the National Electrical Code (NEC), in particular Section 820.93, Grounding of Outer Conductive Shield of a Coaxial Cable.
- Keep the power cord as far away from the antenna wire as possible.
- Auto Tuning. Please refer to page 29.

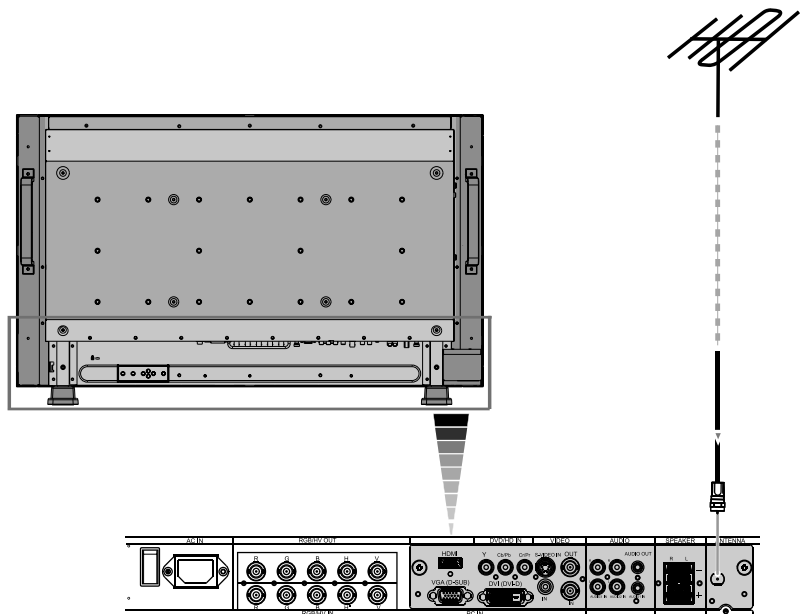

## VHF(300-Ohm) antenna / UHF antenna

- When using a 300-ohm twin lead from an outdoor antenna, connect the VHF or UHF antenna leads to the screws of the VHF or UHF adapter. Plug the 300-ohm to 75-ohm adapter into the antenna on the LCD MONITOR.
- When both VHF and UHF antennas are combined: Attach an optional antenna cable signal combiner to the LCD MONITOR antenna terminal, and connect the cables to the antenna mixer. Consult your local electronics retailer about available signal combiners.

## Reconnect the unit to the power source and turn on the power

- Using the Remote Control or User Controls, select the "TV TUNER". Select the appropriate menu based upon which source (cable or antenna) is being used.
- Refer to page 29 for further information on the "TV TUNER" as well as for information on how to use the "CHANNEL SEARCH" function to program available channels.

**CAUTION:** The screen of the coaxial cable is intended to be connected to earth in the building installation.

## TELETEXT SELECT

Press the  button between TV (VIDEO) picture, TELETEXT or MIXED.

TV PICTURE → TELETEXT → MIXED [TV & TELETEXT]



## PAGE SELECTION

Use the KEYPAD buttons 0 to 9 to select the required page (3 digit number).

## PAGE UP/DOWN

Press the CH +/- buttons to increase or decrease the page number selected.

## HOLD

Some TELETEXT information is contained in more than one page. The pages automatically changing after a given reading time. Press the STILL ON/OFF button to stop the page changing (the symbol  will appear on the page heading). Press the STILL ON/OFF button again to allow the page to change (the symbol  will disappear).

## REVEAL

Some TELETEXT pages contain quiz or game questions with hidden answers. Press the STILL CAPTURE button to see the answers. Press the STILL CAPTURE button again to hide the answers.

## CANCEL

1. Periodically revised NEWS FLASHES can be obtained from TELETEXT broadcasts. Select the News Flash page in TELETEXT mode then press the PIP ON/OFF button. You can now watch the TV program and every time the news flash page is updated it will be automatically displayed in the TV picture. Press the PIP ON/OFF button to cause the news flash to disappear.
2. When a page is selected in TELETEXT mode it may take some time before it becomes available, pressing the PIP ON/OFF button will switch to the TV mode. When the required page is found the page number will appear at the top of the TV picture, press the PIP ON/OFF button to return to the selected TELETEXT page. **Note:** You cannot change TV program while in this mode.

## FAST TEXT (For possible future reference)

The "PICTURE MODE", "SIZE", "SOUND" and "AUDIO INPUT" buttons are used for quick access to color coded pages transmitted by FAST TEXT broadcast.

**RED:** PICTURE MODE  
**GREEN:** SIZE  
**YELLOW:** SOUND  
**CYAN:** AUDIO INPUT

## INDEX

Press the GUIDE button to select the INDEX page.

\*: The product you purchased may not have this feature.

# Basic Operation

## Power ON and OFF Modes

The LCD monitor power indicator will turn green while powered on and will turn red while powered off.

**NOTE:** The Main Power Switch must be in the ON position in order to power up the monitor using the remote control or the Power Button on the front of the LCD.

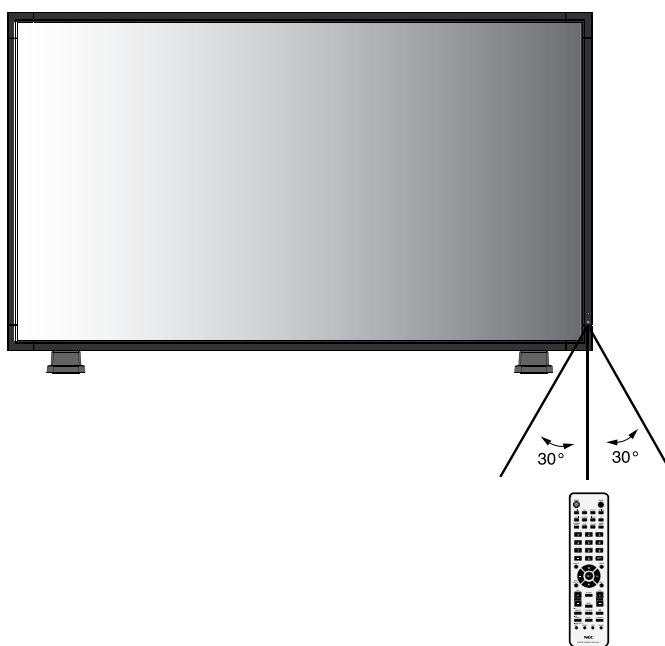
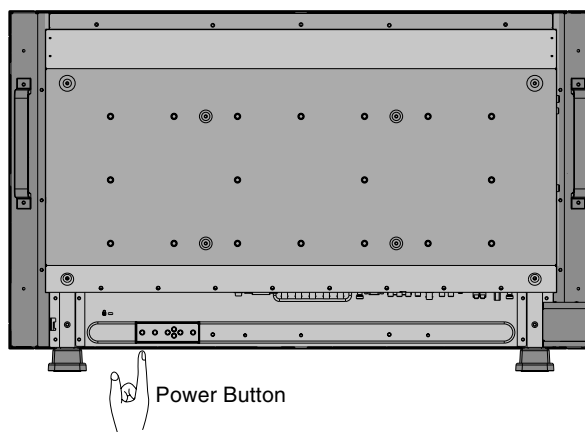
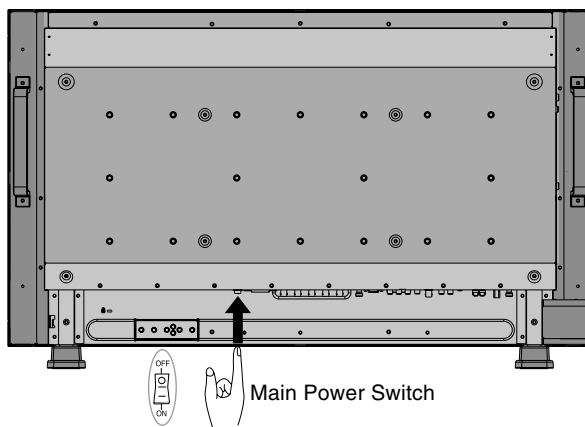

## Power Indicator

Mode	Status Indicator Light
Power ON	Green*2
Power OFF (Eco Standby)*1 Power consumption under 1W	Red
Power OFF (Standby) Power consumption under 5W	Amber
Power Save	Amber Blinking
Power Standby when "SCHEDULE SETTINGS" enabled	Green and Amber blink alternately
Diagnosis (Detecting failure)	Red Blinking (See <b>Troubleshooting</b> page 35)

\*1 When in Eco Standby Mode RS-232C controls do not function.  
\*2 If "OFF" is selected in POWER INDICATOR (page 27), the LED will not light when the LCD monitor is in active mode.

## Using Power Management

The LCD monitor follows the VESA approved DPM Power Management function.

The power management function is an energy saving function that automatically reduces the power consumption of the display when the keyboard or the mouse has not been used for a fixed period.

The power management feature on your new display has been set to the "ON" mode. This allows your display to enter a Power Saving Mode when no signal is applied. This could potentially increase the life and decrease the power consumption of the display.

STANDBY mode is used when the display is connected to an RS-232C cable or when using the INPUT DETECT function.

ECO STANDBY uses less power, but the RS-232C and INPUT DETECT functions are not available.

## Selecting a video source

### To view a video source:

Use the input button to set [VIDEO].

Use the COLOR SYSTEM menu to set [AUTO], [NTSC], [PAL], [SECAM], [PAL60], [4.43NTSC], according to your video format.

## Picture Size

DVI,VGA, RGB/HV FULL → ZOOM → NORMAL  
HDMI, DVD/HD, VIDEO, TV FULL → WIDE\* → ZOOM → NORMAL

Aspect ratio of image	Unchanged view*1	Recommended selection for picture size*1
4:3		NORMAL
		ZOOM (DYNAMIC)
Squeeze		FULL
Letterbox		WIDE*

\*1 Grey areas indicate unused portions of the screen.

**NORMAL:** Display by the inputted signal aspect ratio by PC signal, or display in 4:3 aspect ratio at DVD/HD or VIDEO signal.

**FULL:** Display in entire screen.

**WIDE\*:** Expand 16:9 letter box signal to entire screen.

**ZOOM (DYNAMIC):** Expand 4:3 pictures to the entire screen with non-linearity. (Some around image will be cut by expansion).

### ZOOM

Image can be expanded beyond the active display area. The image which is outside of active display area is not displayed.

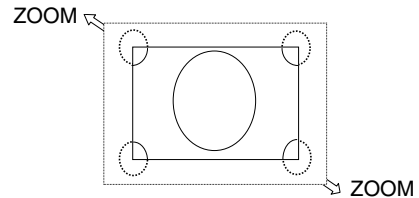

## Picture Mode

DVI,VGA, RGB/HV STANDARD → sRGB → HIGHBRIGHT  
HDMI, DVD/HD, VIDEO, TV STANDARD → CINEMA → HIGHBRIGHT

## Information OSD

The Information OSD provides information such as: Monitor ID, Input Source, Picture Size, etc. Press the DISPLAY button on the remote to bring up the Information OSD.

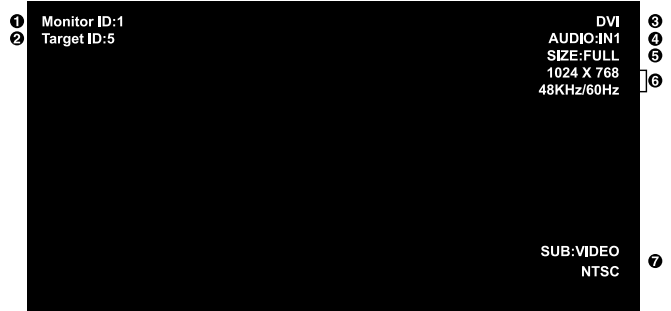

- ❶ ID number assigned to current monitor
- ❷ ID number assigned monitor to be controlled via RS-232C
- ❸ Input Source
- ❹ Audio input mode\*
- ❺ Picture size
- ❻ Input Signal Information
- ❼ Sub picture information

\*: The product you purchased may not have this feature.



# OSD (On-Screen-Display) Controls

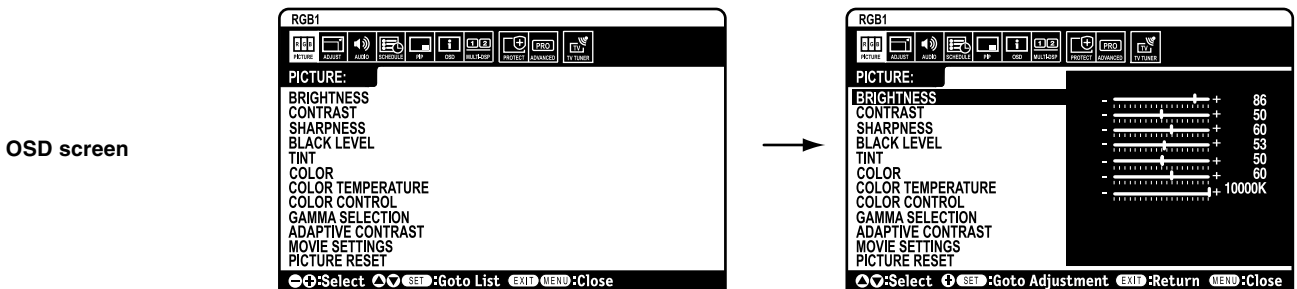
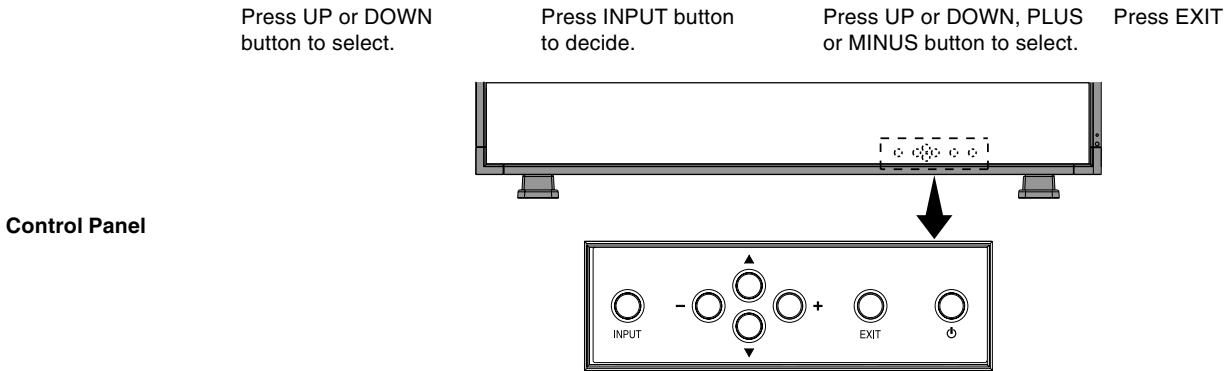
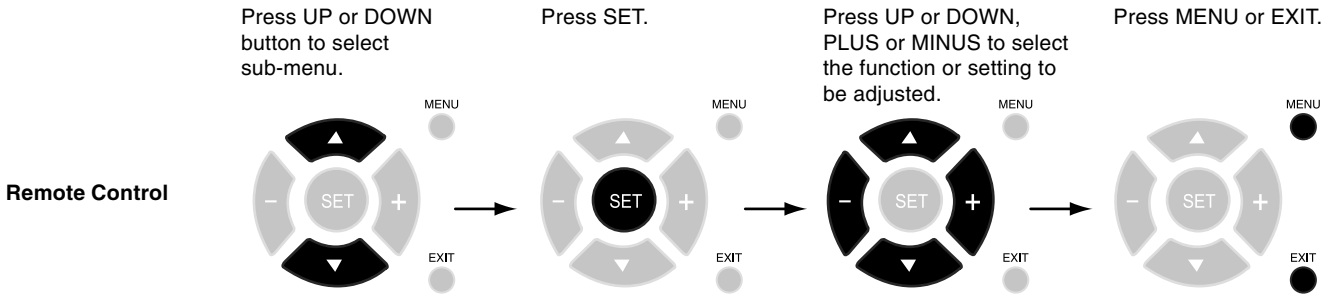
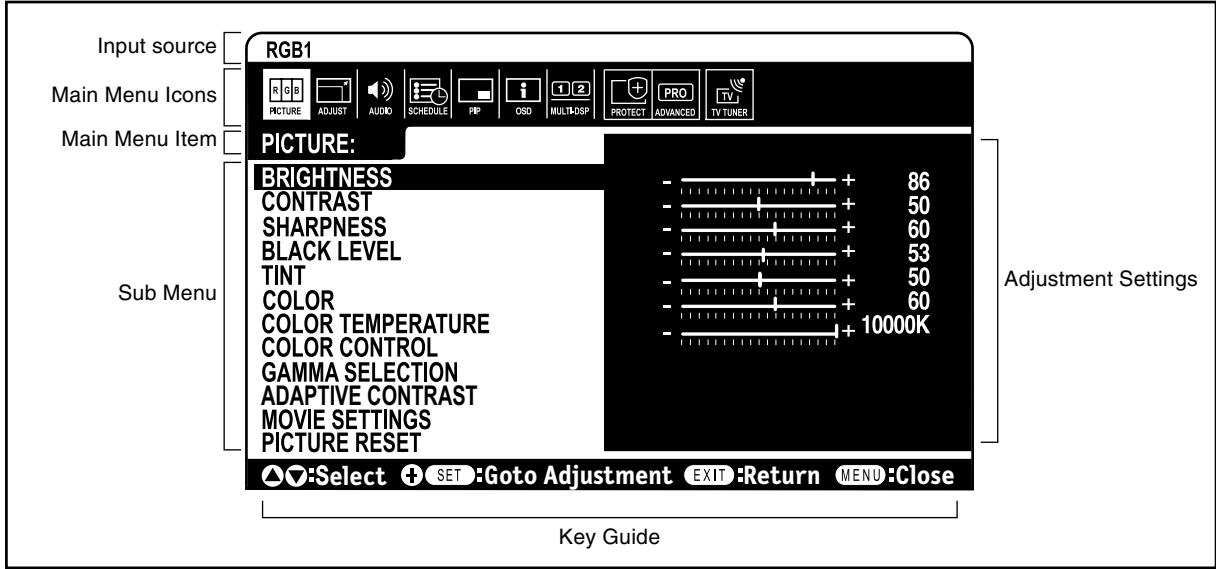

PICTURE	BRIGHTNESS	Adjusts the overall image and background brightness. Press + or - to adjust.
	CONTRAST	Adjusts the image brightness in relationship to the background. Press + or - to adjust. Note: The sRGB picture mode is standard and cannot be changed.
	SHARPNESS	Adjusts the crispness of the image. Press + or - to adjust.
	BLACK LEVEL	Adjusts the image brightness in relationship to the background. Press + or - to adjust.
	TINT* <small>INPUT HDMI, DVD/HD, VIDEO, TV only</small>	Adjusts the tint of the screen. Press + or - to adjust.
	COLOR* <small>INPUT HDMI, DVD/HD, VIDEO, TV only</small>	Adjusts the color depth of the screen. Press + or - to adjust.
	COLOR TEMPERATURE	Adjusts the color temperature of the entire screen. A low color temperature will make the screen reddish. A high color temperature will make the screen bluish. Note: The sRGB picture mode is set to a predefined 6500 K standard and cannot be changed.
	COLOR CONTROL <small>INPUT DVI, VGA, RGB/HV, HDMI only</small>	Adjusts the levels of the Red, Yellow, Green, Cyan, Blue, Magenta and Saturation. Note: The sRGB picture mode is standard and cannot be changed.
	GAMMA SELECTION	Select a display gamma for best picture quality.
	NATIVE	Gamma correction is handled by the LCD panel.
	2.2	Typical display gamma for use with a PC.
	2.4	Good for video (TV, DVD, etc.)
	S GAMMA	Special gamma for certain types of movies. Raises the dark parts and lowers the light parts of the image. (S-Curve)
	DICOM SIM.	DICOM GSDF curve simulated for LCD type.
	PROGRAMMABLE	A programmable gamma curve can be loaded using NEC software.
	ADAPTIVE CONTRAST* <small>INPUT HDMI, DVD/HD, VIDEO, TV only</small>	Sets the level of adjustment for dynamic contrast.
	OFF	
	MID	
	HIGH	
	MOVIE SETTINGS*	
NOISE REDUCTION <small>INPUT TV, VIDEO only</small>	Adjusts the amount of noise reduction. Press + or - to adjust.	
FILM MODE <small>INPUT HDMI, DVD/HD, VIDEO, TV only</small>	Selects Film mode.	
PICTURE RESET	Resets the following settings within the PICTURE menu back to factory setting: BRIGHTNESS, CONTRAST, SHARPNESS, BLACK LEVEL, TINT, COLOR, COLOR TEMPERATURE, COLOR CONTROL, GAMMA SELECTION, ADAPTIVE CONTRAST, MOVIE SETTINGS.	
ADJUST	AUTO SETUP <small>INPUT VGA, RGB/HV only</small>	Automatically adjusts screen size, H position, V position, Clock, Clock Phase, White Level, and Black Level.
	AUTO ADJUST <small>INPUT VGA, RGB/HV only</small>	H Position, V Position and Clock Phase are adjusted automatically upon power on.
	H POSITION	Controls the horizontal position of the image within the Display area of the LCD. Press + to move right. Press - to move left.
	V POSITION	Controls the vertical position of the image within the Display area of the LCD. Press + to move up. Press - to move down.
	CLOCK <small>INPUT VGA, RGB/HV only</small>	Press + to expand the width of the image on the right of the screen. Press - to narrow the width of the image on the left.
	CLOCK PHASE <small>INPUT VGA, RGB/HV, DVD/HD only</small>	Adjusts the visual "noise" on the image.

\*: The product you purchased may not have this feature.

<b>H RESOLUTION</b> INPUT DVI, VGA, RGB/HV only		Adjusts the horizontal size of the image.
<b>V RESOLUTION</b> INPUT DVI, VGA, RGB/HV only		Adjusts the vertical size of the image.
<b>ZOOM MODE</b>		Select the aspect ratio of the screen image.
<b>BASE ZOOM</b>		
16:9*		For input sources that have a 16:9 aspect ratio.
14:9*		For input sources that have a 14:9 aspect ratio.
DYNAMIC*		Expands 4:3 picture to fill the screen. Some of the image is lost due to expansion.
OFF		Selecting "OFF" will display the image in a 1 by 1 pixel format. (If the input resolution is higher than a 1360 x 768 resolution, the image will be scaled down to fit the screen.)
CUSTOM		Displays an image as large as possible without changing the aspect ration.
<b>ZOOM</b>		Maintains the aspect ratio while zooming.
<b>H ZOOM</b>		Amount of horizontal zoom. Can be adjusted for each BASE ZOOM setting.
<b>V ZOOM</b>		Amount of vertical zoom. Can be adjusted for each BASE ZOOM setting.
<b>H POS</b>		Horizontal position. Can be adjusted for each BASE ZOOM setting.
<b>V POS</b>		Vertical position. Can be adjusted for each BASE ZOOM setting.
<b>INPUT RESOLUTION</b> INPUT VGA, RGB/HV only		If there is a problem with signal detection, this function forces the monitor to display the signal at the desired resolution. If no problem is detected, the only available option will be "AUTO".
AUTO		
1024x768		
1280x768		
1360x768		
1366x768		
1440x1050		
1680x1050		
<b>ADJUST RESET</b>		Resets the following settings within the ADJUST menu back to factory setting: AUTO ADJUST, H POSITION, V POSITION, CLOCK, CLOCK PHASE, H RESOLUTION, V RESOLUTION, ZOOM MODE, INPUT RESOLUTION.
AUDIO*	BALANCE	
	TREBLE	
	BASS	
	PIP AUDIO	Selects source of PIP audio.
	AUDIO RESET	Resets "AUDIO" options back to factory settings.
SCHEDULE	<b>OFF TIMER</b>	Sets the monitor to power off after a length of time. A time between 1 to 24 hours is available.
	<b>SCHEDULE SETTING</b>	Creates a working schedule for the monitor to use.
	<b>SCHEDULE LIST</b>	List of schedules.
	<b>DATE &amp; TIME</b>	Sets the date, time, and daylight saving region. Date & time must be set in order for the "SCHEDULE" function to operate.
	YEAR	
	MONTH	
	DAY	

\*: The product you purchased may not have this feature.

	TIME	
	DAYLIGHT SAVING	
	SCHEDULE RESET	

---

PIP	KEEP PIP MODE*	Allows the monitor to remain in "PIP" mode after powering off. When Power is returned, PIP appears without having to enter the OSD.
	PIP MODE*	Picture-in-Picture
	OFF	OFF
	PIP	PIP
	POP	POP
	SIDE BY SIDE (ASPECT)	SIDE BY SIDE ASPECT
	SIDE BY SIDE (FULL)	SIDE BY SIDE FULL
	PIP SIZE	Selects the size of the sub-picture used in Picture-in-Picture (PIP) mode.
	SMALL	
	MIDDLE	
	LARGE	
	PIP POSITION	Determines where the PIP appears on the screen.
	PIP RESET	Resets PIP options back to factory settings.

---

OSD	LANGUAGE	Select the language used by the OSD.
	ENGLISH	
	DEUTSCH	
	FRANÇAIS	
	ITALIANO	
	ESPAÑOL	
	SVENSKA	
	日本語	
	OSD TURN OFF	
	OSD POSITION	Determines the location where the OSD appears on the screen.
	UP	
	DOWN	
	LEFT	
	RIGHT	
	INFORMATION OSD	Selects whether the information OSD is displayed or not. The information OSD will be displayed when the input signal or source changes. The information OSD will also give a warning when there is no-signal or the signal is out-of range. An interval between 3 to 10 seconds for the Information OSD to appear is available.
	MONITOR INFORMATION	Monitor Information.
OSD TRANSPARENCY	Set the transparency level of the OSD.	
OFF		
TYPE1		
TYPE2		

\*: The product you purchased may not have this feature.

	OSD RESET	Resets the following settings within the OSD menu back to factory setting: OSD TURN OFF, OSD POSITION, INFORMATION OSD, OSD TRANSPARENCY.
MULTI DISPLAY	MONITOR ID	Sets the monitor ID number from 1-26.
	IR CONTROL	Selects the mode of the monitor for use with the infra-red remote control when using the RS-232C daisy chain.
	NORMAL	The monitor will be controlled normally by wireless remote controller.
	PRIMARY	Choose "PRIMARY" for the first monitor within an RS-232C daisy chain.
	SECONDARY	Choose "SECONDARY" for all subsequent monitors within an RS-232C daisy chain.
	LOCK	Prevents the monitor from being controlled by wireless remote controller. To return to normal operation, press the "DISPLAY" button on the remote controller for 5 seconds.
	TILE MATRIX	Allows one image to be expanded and displayed over multiple screens (up to 25) through a distribution amplifier.
	H MONITORS	Number of monitors arranged horizontally.
	V MONITORS	Number of monitors arranged vertically.
	POSITION	Select which section of the tiled image to be displayed on the monitor.
	TILE COMP	Turns the TILE COMP feature on.
	ENABLE	Enables Tile Matrix.
	POWER ON DELAY	Adjusts the delay time between being in "standby" mode and entering "power on" mode. "POWER ON DELAY" can be set between 0 and 50 seconds.
	POWER INDICATOR	Turns ON or OFF the LED located at the front of the monitor. If "OFF" is selected, LED will not light when the LCD monitor is in active mode.
MULTI DISPLAY RESET	Resets the following settings within the MULTI DISPLAY menu back to factory setting: MONITOR ID, IR CONTROL, TILE MATRIX, POWER ON DELAY.	
DISPLAY PROTECTION	POWER SAVE <small>except TV input</small>	Sets how long the monitor waits to go into power save mode after a lost signal. Note: When connecting DVI, video card might not stop sending digital data even if image has disappeared. In this case the monitor does not get to power management mode.
	STANDBY MODE	Lowers power consumption. Note: RS-232C Function is lost when in Eco Standby mode.
	HEAT STATUS	Displays status of the COOLING FAN, BRIGHTNESS and TEMPERATURE.
	FAN CONTROL	Cooling fan reduces the temperature of the display.
	SCREEN SAVER	Use the SCREEN SAVER function to reduce the risk of Image Persistence.
	GAMMA	The display gamma is changed and fixed when "ON" is selected.
	BRIGHTNESS	The brightness is decreased when "ON" is selected.
	MOTION	The screen image is slightly expanded and moves in 4 directions (UP, DOWN, RIGHT, LEFT) at user determined intervals.
	SIDE BORDER COLOR	Adjusts the color of the side borders when a 4:3 image is displayed. Press + button, the bar will become lighter. Press - button, the bar will become darker.
	AUTO BRIGHTNESS <small>INPUT DVI, VGA, RGB/HV only</small>	Adjusts the brightness level according to the input signal.
	CHANGE SECURITY PASSWORD	Allows the security password to be changed. The factory preset password is 0000.
	SECURITY LOCK	Locks the security password.
	DDC/CI	ENABLE/DISABLE: Turns On or OFF the two way communication and control of the monitor.
	DISPLAY PROTECTION RESET	Resets the following settings within the Picture menu back to factory setting: POWER SAVE, STANDBY MODE, FAN CONTROL, SCREEN SAVER, SIDE BORDER COLOR, AUTO BRIGHTNESS.

\*: The product you purchased may not have this feature.

**ADVANCED  
OPTION**

<b>INPUT DETECT</b> <small>except TV input</small>	Selects the method of input detection the monitor uses when more than two input devices are connected.
NONE	The Monitor will not search the other video input ports.
<b>FIRST DETECT</b> <small>INPUT DVI, VGA, RGB/HV only</small>	When the current video input signal is not present, then the monitor searches for a video signal from the other video input port. If the video signal is present in the other port, then the monitor switches the video source input port to the new found video source automatically. The monitor will not look for other video signals while the current video source is present.
<b>LAST DETECT</b> <small>INPUT DVI, VGA, RGB/HV only</small>	When the monitor is displaying a signal from the current source and a new secondary source is supplied to the monitor, the monitor will automatically switch to the new video source. When current video input signal is not present, the monitor searches for a video signal from the other video input port. If the video signal is present in the other port, then the monitor switches the video source input port to the new found video source automatically.
<b>VIDEO DETECT*</b>	DVD/HD or VIDEO inputs will have priority over DVI, VGA, RGB/HV. When DVD/HD or VIDEO input signal is present the monitor will change and keep to the DVD/DH or VIDEO input.
<b>LONG CABLE ON/OFF</b> <small>INPUT VGA, RGB/HV only</small>	Compensates for image degradation caused from using a long cable.
<b>LONG CABLE MANUAL</b> <small>INPUT VGA, RGB/HV only</small>	Manually compensates for image degradation caused from using a long cable.
<b>RED DELAY</b>	Adjusts the phase of the red signal.
<b>GREEN DELAY</b>	Adjusts the phase of the green signal.
<b>BLUE DELAY</b>	Adjusts the phase of the blue signal.
<b>RED SHARPNESS</b>	Adjusts the performance degradation of the RED signal.
<b>GREEN SHARPNESS</b>	Adjusts the performance degradation of the GREEN signal.
<b>BLUE SHARPNESS</b>	Adjusts the performance degradation of the BLUE signal.
<b>SOG PEAK.</b>	Adjusts the shape of Sync on Green signal.
<b>VIDEO EQ.</b>	Optimize the shape (Tailing) of RED, GREEN and BLUE signals.
<b>SYNC TERMINATE</b>	Selects the terminate resistance for matching the cable impedance.
<b>DVI MODE</b>	Selects the kind of DVI-D equipment which is connected DVI. Select "DVI-PC" when PC or other computer equipment is connected. Select "DVI-HD" when DVD player, which has DVI-D output, is connected.
<b>SCAN CONVERSION</b> <small>except VGA, RGB/HV</small>	Selects the IP (Interlace to Progressive) conversion function.
<b>PROGRESSIVE</b>	Converts interlaced signals to progressive. This is the default setting.
<b>INTERLACE</b>	Disables IP conversion. This setting is best suited for motion pictures, but increases the risk of image retention.
<b>SCART MODE*</b>	Input mode for devices using SCART connectors.
<b>S-VIDEO MODE*</b>	Selects the S-Video input port function.
<b>PRIORITY</b>	When an S-Video cable is connected to the S-Video input, it will have priority over the composite input port.
<b>SEPARATE</b>	The S-Video port and Composite port can be selected as independent input ports.
<b>COLOR SYSTEM</b> <small>INPUT VIDEO only</small>	The selected Color System depends on the video format of the input signal.
<b>AUTO</b>	Automatically chooses Color System setting based on input signal.
<b>NTSC</b>	
<b>PAL</b>	
<b>SECAM</b>	
<b>4.43NTSC</b>	
<b>PAL-60</b>	

\*: The product you purchased may not have this feature.

SCAN MODE* INPUT HDMI, DVD/HD, VIDEO, TV only	Some video formats may require scan conversion in order to best display the image.
OVER SCAN	Image size is larger than what can be displayed. The image edge will appear cropped. Approximately 95% of the image will be shown on the screen.
UNDER SCAN	Image size stays within the display area. The whole image is displayed on the screen.
ADVANCED OPTION RESET	Resets the following settings within the ADVANCED OPTION menu back to factory setting: INPUT DETECT, LONG CABLE ON/OFF, LONG CABLE MANUAL, DVI MODE, SCAN CONVERSION, S-VIDEO MODE, SCAN MODE.
FACTORY RESET	Resets OSD options back to factory settings EXCEPT FOR: CHANGE SECURITY PASSWORD and SECURITY PASSWORD.

TV TUNER*	REGION	Selects region.
	CHANNEL SEARCH	Automatically stores available channels.
	CHANNEL EDIT	Manually adds or removes channels from TV mode.

\*: The product you purchased may not have this feature.

### NOTE 1: CREATING A SCHEDULE

The schedule function allows the display to be set to power on and off at different times. Up to seven different schedules can be programmed.

To program the schedule:

1. Enter the SCHEDULE menu. Highlight SCHEDULE SETTING using the up and down buttons. Press the SET or the + button to enter the Settings menu. Highlight the desired schedule number and press set. The box next to the number will turn yellow. The schedule can now be programmed.
2. Use the up and down arrows to highlight INPUT. Use the + and - buttons to choose the input source.
3. After the INPUT source is selected, use the down button to highlight the hours setting in the ON timeslot. Use the + and - buttons to set the hour. Use the up and down buttons to highlight the minutes setting. Use the + and - buttons to set the minutes. Set the OFF time in the same manner.
4. Use the down button to select a day on which the schedule will be enabled. Push the set button to enable. If the schedule is to be ran every day, use the choose EVERY DAY and press the SET button the circle next to EVERY DAY will turn yellow. If a weekly schedule is desired, choose the days of the week using the up and down buttons and pressing SET to select. Then highlight the EVERY WEEK option and press SET.
5. After a schedule is programmed the remaining schedules can then be set. Press MENU to leave the OSD or press EXIT to go back to the previous menu.

**Note:** If schedules are overlapping then the schedule with the highest number will have priority over the schedule with the lowest number. For example schedule #7 will have priority over schedule #1.

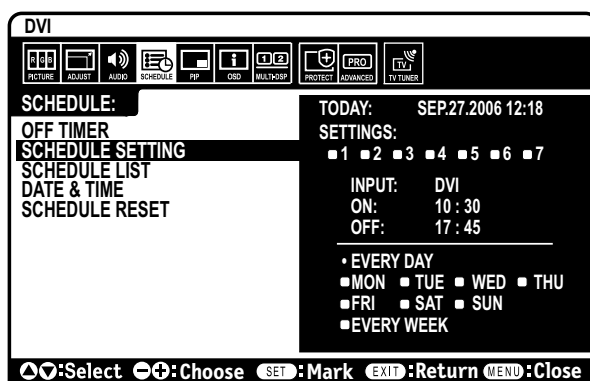

**NOTE 2: IMAGE PERSISTENCE**

Please be aware that LCD Technology may experience a phenomena known as Image Persistence. Image Persistence occurs when a residual or “ghost” image of a previous image remains visible on the screen. Unlike CRT monitors, LCD monitors’ image persistence is not permanent, but constant images being displayed for a long period of time should be avoided.

To alleviate image persistence, turn off the monitor for as long as the previous image was displayed. For example, if an image was on the monitor for one hour and a residual image remains, the monitor should be turned off for one hour to erase the image.

As with all personal display devices, NEC DISPLAY SOLUTIONS recommends displaying moving images and using a moving screen saver at regular intervals whenever the screen is idle or turning off the monitor when not in use.

Please set “SCREEN SAVER”, “DATE &TIME” and “SCHEDULE SETTINGS” functions to further reduce the risk of Image persistence.

**For long life use of Public Display**

**< Image Sticking of LCD Panel >**

When LCD panel is operated continuously for long hours, a trace of electric charge remains near the electrode inside LCD, and residual or “ghost” image of previous image may be observed. (Image Persistence)

Image Persistence is not permanent, but when fixed image is displayed for long period, ionic impurities inside LCD are accumulated along the displayed image, and it is observed permanently. (Image Sticking)

**< Recommendations >**

For preventing the fast transition to Image Sticking, and for longer life usage of LCD, following are recommended.

1. Fixed image should not be displayed for long period, and changed to another images with short cycle.
2. When no use, please turn off the monitor by remote control, or use Power Management Function of monitor or use Schedule Function of monitor.
3. Reducing the environmental temperature is effective for long life use.  
When Protection board (glass, acryl) is installed over the LCD surface, enclosed into the box / wall, or stack the monitor, please utilize the temperature sensors inside monitor.  
To reduce the environmental temperature, the monitor should be set Low Brightness or Cooling Fan “ON” by using Screen sever Function.
4. Please use “Screen Saver Mode” of monitor.

**Remote Control ID Function**

**REMOTE CONTROL ID**

The remote control included with the display can be used to control up to 26 individual MultiSync monitors using what is called the REMOTE CONTROL ID mode. The REMOTE CONTROL ID mode works in conjunction with the Monitor ID, allowing control of up to 26 individual MultiSync monitors. For example: if there are many monitors being used in the same area, a remote control in normal mode would send signals to every monitor at the same time Figure 1. Using the remote in REMOTE CONTROL ID mode will only operate one specific monitor within the group Figure 2.

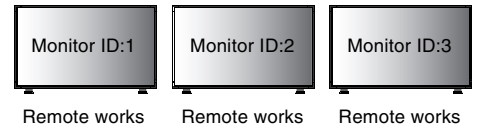

Figure 1  
Remote in Normal mode or the REMOTE ID is set to 0

**TO SET REMOTE CONTROL ID**

While holding down the REMOTE ID SET button on the remote control, use the KEYPAD to input the Monitor ID (1-26) of the display to be controlled via remote. The remote can then be used to operate the monitor having that specific Monitor ID number.

When 0 is selected or when the remote control is in normal mode, all monitors will be operated.

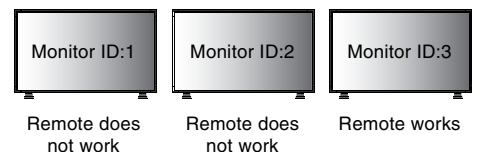

Figure 2  
Remote set up to use REMOTE ID:3

**TO SET REMOTE CONTROL ID**

ID Mode - To enter ID Mode press the REMOTE ID SET button and hold down for 2 seconds.

Normal Mode - To return to Normal Mode press the REMOTE ID RESET button and hold down for 2 seconds.

In order for this feature to work properly, the display must be assigned a Monitor ID number. The Monitor ID number can be assigned under the MULTI DISPLAY menu in the OSD (See page 27).

Press the “DISPLAY” button on the remote to bring up the Information OSD. The Information OSD shows the monitor ID number and other information such as signal type, zoom method, etc.



**This LCD monitor can be controlled via personal computer or wireless remote control using an RS-232C connection.**

## **MONITOR ID and IR CONTROL**

Using one PC or one infrared wireless controller, up to 26 individual LCD4020/LCD4620 monitors can be controlled through a daisy chain via RS-232C connection.

### **1. Connect PC and LCD4020/LCD4620.**

Connect a PC's RS-232C control output to the LCD4020/LCD4620's RS-232C input. You can then connect the RS-232C output from the LCD4020/LCD4620 to another LCD4020/LCD4620's RS-232C input. Up to 26 monitors can be connected using RS-232C.

### **2. Set Monitor ID and IR Control mode.**

For proper operation, the Monitor ID should be set in the OSD menu of each monitor that is in the chain. The Monitor ID can be set under the "MULTI DISPLAY" menu in the OSD. The Monitor ID number can be set within a range from 1 to 26. No two monitors should share the same Monitor ID number. It is recommended to number each monitor in a daisy chain sequentially from 1. The first monitor in the daisy chain is designated as the primary monitor. Subsequent monitors with the chain are secondary monitors.

In the "ADVANCED OPTION" menu on the first monitor in the RS-232C daisy chain set the "IR CONTROL" to "PRIMARY".

Set the "IR CONTROL" to "SECONDARY" on all other monitors.

### **3. Press the "DISPLAY" button on the remote control while aiming at the "PRIMARY" monitor. The Information OSD will be shown at top left side of the screen.**

**Monitor ID:** Displays the ID number of the current monitor within the daisy chain.

**Target ID:** Displays the ID number of the monitor that to be controlled via daisy chain from the current monitor.

Press the "+" or "-" buttons to change the "Target ID" to show the ID number of the monitor to be controlled. To control the entire daisy chained monitors simultaneously, select "ALL" as the "Target ID."

**Note:** If the monitor is in ECO Standby mode, RS-232C functionality is stopped.

### **4. Use the wireless remote controller to control the "SECONDARY" monitor while aiming at the "PRIMARY" monitor.**

The "MENU OSD" will appear on the selected target monitor.

**NOTE:** If the "ID No." mode select OSD is showing, press the "DISPLAY" button on the remote control while pointing at the "PRIMARY" monitor to clear this OSD.

**HINT:** If you lost control due to the incorrect setting of "IR CONTROL", pressing the "DISPLAY" button on the remote control for 5 or more seconds will reset the "IR CONTROL" menu to "NORMAL" function.

# Controlling the LCD monitor via RS-232C Remote Control

This LCD monitor can be controlled by connecting a personal computer with a RS-232C terminal.

Functions that can be controlled by a personal computer are:

- Power ON or OFF
- Switching between input signals

## Connection

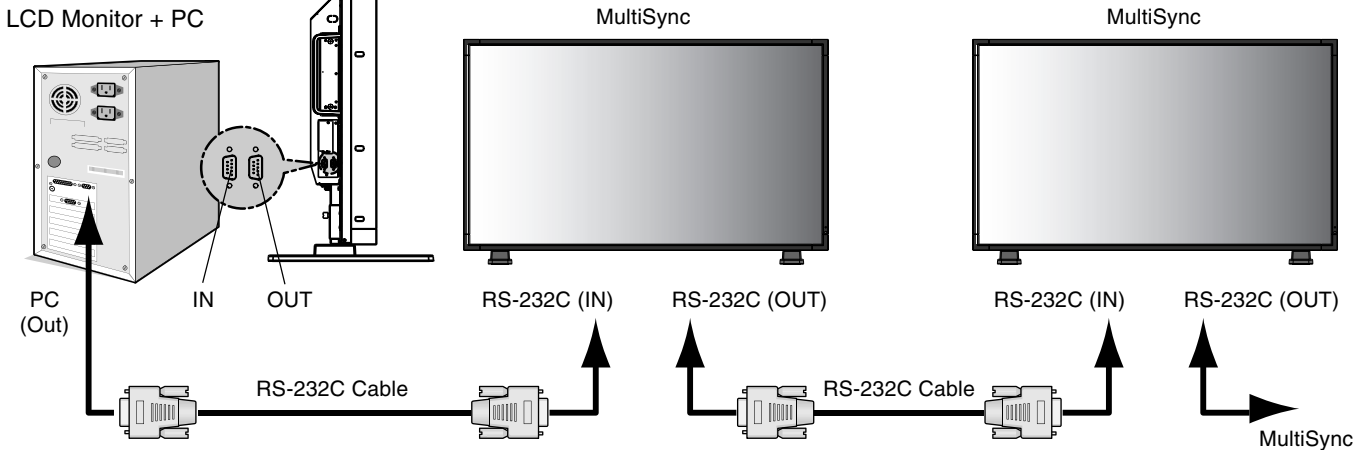

**NOTE:** If your PC (IBM or IBM compatible) is equipped only with a 25-pin serial port connector, a 25-pin serial port adapter is required. Contact your dealer for details.

\* In order to function, the RS-232C OUT terminal can only be connected to another monitor of the same model. Do not connect to other types of equipment.

The following control sequence is used for a single LCD4020/LCD4620. To control multiple LCD4020/LCD4620 monitors that are daisy-chained together please use the extended control command. Instructions for the extended control command can be found on the CD included with the display. The file is called "External\_control\_LCD4X20.pdf". When using the following control commands, all of the daisy-chained monitors can be controlled at the same time from one monitor. Reply and status commands, however, will only pertain to the primary monitor, not secondary monitors.

### 1) Interface

PROTOCOL	RS-232C
BAUD RATE	9600 [bps]
DATA LENGTH	8 [bits]
PARITY BIT	NONE
STOP BIT	1 [bits]
FLOW CONTROL	NONE

This LCD monitor uses RXD, TXD and GND lines for RS-232C control.

### 2) Control command diagram

The command is structured by the address code, function code, data code and end code. The length of the command is different for each function.

	Address code	Function code	Data code	End code
HEX	30h 30h	Function	Data	0Dh
ASCII	'0' '0'	Function	Data	↵

- [Address code] 30h 30h (ASCII code, '0' '0'), fixed.
- [Function code] A code of each fixed control move.
- [Data code] A code of each fixed control data (number) and not always indicated.
- [End code] 0Dh (In ASCII code, '↵') fixed.

## 3) Control sequence

- (1) The command from a computer to the LCD monitor will be sent in 400ms.
- (2) The LCD monitor will send a return command 400ms\* after it has received and encoded. If the command isn't received correctly, the LCD monitor will not send the return command.
- (3) The personal computer checks the command and confirms if the command, which has been sent, has been executed or not.
- (4) This LCD monitor sends various codes other than return code. When having a control sequence by RS-232C, reject other codes from personal computers side.

\*: The sending time of return command may delay depending on the condition (during changing of the input signal, etc.).

Example: Turn the power ON ( ' ' is for ASCII code)

Sending commands from the PC	Status code from LCD monitor	Meaning
30 30 21 0D '0' '0' '!' '↵'		Command for POWER ON
	30 30 21 0D '0' '0' '!' '↵'	Command received (Command echoed back)

## 4) Operation commands

The operation commands execute the basic operation setting of this LCD monitor.

It may not operate when changing the signal:

Operation	ASCII	HEX	Operation	ASCII	HEX
POWER ON	!	21h	INPUT HDMI	_h1	5Fh 68h 31h
POWER OFF	"	22h	INPUT VIDEO*1	_v1	5Fh 76h 31h
INPUT DVI	_r1	5Fh 72h 31h	INPUT DVD/HD	_v2	5Fh 76h 32h
INPUT VGA	_r2	5Fh 72h 32h	INPUT S-VIDEO*2	_v3	5Fh 76h 33h
INPUT RGB/HV	_r3	5Fh 72h 33h	INPUT TV	_t1	5Fh 74h 31h

- POWER OFF command should be operated over 1 minute after the power is turned on.
- POWER ON command should be operated over 1 minute after the power is turned off.

\*1 S-VIDEO is enabled by having the "S-VIDEO" cable connected with the "S-VIDEO" signal present and selecting "PRIORITY MODE".

\*2 S-VIDEO is SEPARATE only.

## 5) Read command

Host computer sends the command without Data-code to monitor.

After receiving this command, the monitor returns the command with Data-code of current status to host computer.

< ex. > When Host computer ask Power status of monitor, the status of monitor is powered-on.

Command from computer	Command from Monitor	Detail of command
30 30 76 50 0D 0"0"v"P[enter]		Ask about the power status of monitor.
	30 30 76 50 31 0D 0"0"v"P"1"[enter]	Monitor is powered-on.

Structure of the Read-command

		ASCII		HEX	
		Function	Data (Receive)	Function	Data (Receive)
POWER	ON	vP	1	76 50	31
	OFF(stand by)	vP	0	76 50	30
Input	DVI(DVI-D)	vl	r1	76 49	72 31
	VGA(D-SUB)	vl	r2	76 49	72 32
	RGB/HV(BNC)	vl	r3	76 49	72 33
	HDMI	vl	h1	76 49	68 31
	Video	vl	v1	76 49	76 31
	DVD/HD	vl	v2	76 49	76 32
	S-VIDEO	vl	v3	76 49	76 33
	TV	vl	t1	76 49	74 31
Picture mode	HIGHBRIGHT	vM	p1	76 4D	70 31
	STANDARD	vM	p2	76 4D	70 32
Temperature of Internal monitor	Around AV board	resolution 0.5°C	tcx1	(ex.) +25.0	74 63 78 31
		resolution 1°C	tc1	(ex.) +25	74 63 31
	Around Inverter PCB	resolution 0.5°C	tcx2	(ex.) +30.5	74 63 78 32
		resolution 1°C	tc2	(ex.) +31	74 63 32
	Around Mainboard	resolution 0.5°C	tcx3	(ex.) +30.5	74 63 78 33
		resolution 1°C	tc3	(ex.) +31	74 63 33

**NOTE:** For complete information please see file "External\_Control\_LCD4X20.pdf" on the CD-ROM.

# Features

---

**Reduced Footprint:** Provides the ideal solution for environments requiring superior image quality but with size and weight limitations.

**Colour Control Systems:** Allows you to adjust the colours on your screen and customize the colour accuracy of your monitor to a variety of standards.

**OmniColor:** Combines Six-axis colour control and the sRGB standard. Six-axis colour control permits colour adjustments via six axes (R, G, B, C, M and Y) rather than through the three axes (R, G and B) previously available. The sRGB standard provides the monitor with a uniform colour profile. This assures that the colours displayed on the monitor are exactly the same as on the colour printout (with sRGB supporting operating system and sRGB printer). This allows you to adjust the colours on your screen and customise the colour accuracy of your monitor to a variety of standards.

**sRGB Colour Control:** A new optimized colour management standard which allows for colour matching on computer displays and other peripherals. The sRGB standard, which is based on a calibrated colour space, allows for optimal colour representation and backward compatibility with other common colour standards.

**OSD (On-Screen-Display) Controls:** Allow you to quickly and easily adjust all elements of your screen image via simple to use on-screen menus.

**Plug and Play:** The Microsoft® solution with the Windows® operating system facilitates setup and installation by allowing the monitor to send its capabilities (such as screen size and resolutions supported) directly to your computer, automatically optimizing display performance.

**IPM (Intelligent Power Manager) System:** Provides innovative power-saving methods that allow the monitor to shift to a lower power consumption level when on but not in use, saving two-thirds of your monitor energy costs, reducing emissions and lowering the air conditioning costs of the workplace.

**FullScan Capability:** Allows you to use the entire screen area in most resolutions, significantly expanding image size.

**VESA Standard (FDMLv1) Mounting Interface:** Allows users to connect their LCD monitor to any VESA standard (FDMLv1) third party mounting arm or bracket. Allows for the monitor to be mounted on a wall or an arm using any third party compliant device. NEC recommends using mounting interface that comply with TÜV-GS and/or UL1678 standard in North America.

**DVI-D:** The digital-only subset of DVI ratified by the Digital Display Working Group (DDWG) for digital connections between computers and displays. As a digital-only connector, analog support is not provided off a DVI-D connector. As a DVI-based digital only connection, only a simple adapter is necessary for compatibility between DVI-D and other DVI-based digital connectors such as DFP and P&D. The DVI interface of this display supports HDCP.

**TILE MATRIX, TILE COMP:** Demonstrates multiple screens with an accurate image and compensates for the bezel width.

**ZOOM:** Expands the image individually for horizontal and vertical direction.

**RS-232C daisy chain:** You can control the multiple monitors by controller or wireless remote controller.

**Self-diagnosis:** When an internal error should occur, a failure state will be indicated.

**CableComp:** Automatic long cable compensation prevents image quality degradation (colour shift and dull signals) caused by long cable lengths.

# Troubleshooting

## No picture

- The signal cable should be completely connected to the display card/computer.
- The display card should be completely seated in its slot.
- Front Power Switch and computer power switch should be in the ON position.
- Check to make sure that a supported mode has been selected on the display card or system being used. (Please consult display card or system manual to change graphics mode.)
- Check the monitor and your display card with respect to compatibility and recommended settings.
- Check the signal cable connector for bent or pushed-in pins.

## Power Button does not respond

- Unplug the power cord of the monitor from the AC outlet to turn off and reset the monitor.

## Image persistence

- Please be aware that LCD Technology may experience a phenomenon known as Image Persistence. Image Persistence occurs when a residual or “ghost” image of a previous image remains visible on the screen. Unlike CRT monitors, LCD monitors’ image persistence is not permanent, but constant images being displayed for a long period of time should be avoided. To alleviate image persistence, turn off the monitor for as long as the previous image was displayed. For example, if an image was on the monitor for one hour and a residual image remains, the monitor should be turned off for one hour to erase the image.

**NOTE:** As with all personal display devices, NEC DISPLAY SOLUTIONS recommends displaying moving images and using a moving screen saver at regular intervals whenever the screen is idle or turning off the monitor when not in use.

## Image is unstable, unfocused or swimming is apparent

- Signal cable should be completely attached to the computer.
- Use the OSD Image Adjust controls to focus and adjust display by increasing or decreasing the fine adjustment. When the display mode is changed, the OSD Image Adjust settings may need to be re-adjusted.
- Check the monitor and your display card with respect to compatibility and recommended signal timings.
- If your text is garbled, change the video mode to non-interlace and use 60Hz refresh rate.

## Image of component signal is greenish

- Check to see if the DVD/HD input connector is selected.

## LED on monitor is not lit

### (no green or red colour can be seen)

- Power Switch should be in the ON position and power cord should be connected.
- Make certain the computer is not in a power-saving mode (touch the keyboard or mouse).

## RED LED on monitor is blinking

- A certain failure might have occurred, please contact your nearest authorized NEC DISPLAY SOLUTIONS service facility.

## Display image is not sized properly

- Use the OSD Image Adjust controls to increase or decrease the coarse adjustment.
- Check to make sure that a supported mode has been selected on the display card or system being used. (Please consult display card or system manual to change graphics mode.)

## Selected resolution is not displayed properly

- Use OSD Display Mode to enter Information menu and confirm that the appropriate resolution has been selected. If not, select corresponding option.

## No Sound

- Check to see if speaker cable is properly connected.
- Check to see if mute is activated.
- Check to see if volume is set at minimum.

## Remote Control is not available

- Check the Remote Control’s batteries status.
- Check if batteries are inserted correctly.
- Check if the Remote Control is pointing at the monitor’s remote sensor.
- Check the Remote Control Mode status.
- The remote control system may not function when direct sunlight or strong illumination strikes the remote control sensor of the LCD monitor, or when there is an object in the path.

## “SCHEDULE”/“OFF TIMER” function is not working properly

- The “SCHEDULE” function will be disabled when the “OFF TIMER” is set.
- If the “OFF TIMER” function is enable and the power to the LCD monitor is turned off if the power supply is interrupted unexpectedly, then the “OFF TIMER” will be reset.

## RS-232C is not working

- Make sure the monitor is not in “Eco Standby” mode (see page 27).

## Snowy Picture, Poor Sound in TV

- Check antenna/cable connection. Use new cable if necessary.

## Interference in TV

- Check components for shielding, move away from monitor if necessary.

Either light vertical or horizontal stripes may appear, depending on the specific display pattern. This is no product fault or degradation.

# Specifications - LCD4020

## Product Specifications

LCD Module		Pixel Pitch: Resolution: Colour: Brightness: Contrast Ratio: Viewing Angle: Design View Distance:	40" /101.6cm diagonal 0.648mm 1366 x 768 dots Over 16 million colours (depending on video card used) 700cd/m <sup>2</sup> (Max.), 500cd/m <sup>2</sup> (Typ.) 1200:1 Up 89°/ Down 89°/ Left 89°/ Right 89° (typ) @ CR>10 1100mm
Frequency		Horizontal: Vertical:	15.625/15.734kHz, 31.5kHz - 91.1kHz (Analog Input) 31.5kHz - 91.1kHz (Digital Input) 50.0 - 85.0 Hz
Pixel Clock			25.2MHz - 162.0MHz
Viewable Size			885.168 x 497.664mm
Input Signal			
DVI	DVI-D 24pin	Digital RGB	DVI (HDCP) VGA60, SVGA60, XGA60, WXGA60, SXGA60, UXGA60*, 1920X1080* (60Hz)
VGA	15pin Mini D-sub	Analog RGB	0.7V p-p, Input Impedance 75 ohm VGA60, SVGA60, XGA60, WXGA60, SXGA60, UXGA60*, 1920X1080* (60Hz)
		Sync	Separate: TTL level (Pos./Neg.) Composite sync on Green Video: 0.3Vp-p Neg.
RGB/HV	BNC (R,G,B,H,V)	Analog RGB	0.7V p-p, Input Impedance 75 ohm VGA60, SVGA60, XGA60, WXGA60, SXGA60, UXGA60*, 1920X1080* (60Hz)
		Sync	Separate: TTL level (Pos./Neg.) Composite sync on Green Video: 0.3Vp-p Neg.
HDMI	HDMI Type-A	Digital RGB	HDMI 1080p*, 1080i*, 720p@50Hz/60Hz, 576p@50Hz, 480p@60Hz
DVD/HD	RCA (Y, Cb/Pb, Cr/Pr)	Component	Y : 1.0Vp-p/75ohm, Cb/Cr (Pb/Pr) : 0.7Vp-p/75 ohm HDTV/DVD:1080p*, 1080i*, 720p@50Hz/60Hz, 576p@50Hz, 480p@60Hz, 576i@50Hz, 480i@60Hz
VIDEO	BNC RCA	Composite	1.0V p-p Input Impedance 75 ohm NTSC/PAL/SECAM/4.43NTSC/PAL60
S-VIDEO	Mini DIN 4 pin	S-VIDEO	Y: 1.0Vp-p/75 ohm C: 0.286Vp-p/75 ohm (NTSC), 0.3Vp-p/75 ohm (PAL/SECAM) NTSC/PAL/SECAM/4.43NTSC/PAL60
Output Signal			
RGB/HV	BNC (R,G,B,H,V)	Analog RGB	Analog RGB Video: 0.7V p-p with 75 ohm terminated Separate HV sync: TTL level (Posi / Nega)
VIDEO	BNC	Composite	Composite 1.0V p-p with 75 ohm terminated
AUDIO			
AUDIO Input	RCA (L/R) X2 STEREO Mini Jack	Analog Audio	Stereo L/R 0.5Vrms
	HDMI Type-A	Digital Audio	PCM 32, 44.1, 48KHz (16/20/24bit)
AUDIO Output	STEREO Mini Jack	Analog Audio	STEREO Mini Jack L/R: 1, 0.5Vrms
Speaker Output			External Speaker Jack 15W + 15W (8 ohm)
Control		RS-232C In: RS-232C Out:	9 Pin D-sub 9 Pin D-sub (with daisy chain)
TV		F-connector: Channel Coverage:	Antenna Impedance 75ohm VHF: E2 to E12/R1 to R12 UHF: E21 to E69 CATV: S1 to S41
Power Supply			3.0 - 1.2 A @ 100-240VAC, 50/60Hz
Operational Environment		Temperature: Humidity:	5 - 40°C (Default brightness), 5 - 20°C (Max brightness) 20 - 80% (without condensation)
Storage Environment		Temperature: Humidity:	-20 - 60°C 10 - 90% (without condensation)/ 90% - 3.5% x (Temp - 40°C) regarding over 40°C
Dimension		Net: Gross:	919.7 (W) x 567.7 (H) x 330 (D) mm (with stand) 919.7 (W) x 532.2 (H) x 140 (D) mm (without stand) 1147 (W) x 761 (H) x 312 (D) mm
Weight		Net: Gross:	31.1Kg (With stand), 29.4Kg (Without stand) 38.9Kg
VESA compatible arm mounting interface			3 x 200mm x 200mm (8 Holes) 2 x 200 mm x 200 mm (6 Holes)
Complied Regulatory and Guidelines			UL60950-1/CSA C22.2 No.60950-1/ TUV-GS/EN60950-1/NOM FCC-B/DOC-B/EN55022-A/EN55024/EN61000-3-2/EN61000-3-3/CE/GOST-R
Power Management			VESA DPM
Plug & Play			VESA DDC2B, DDC/CI
Accessories			User's manual, Power Cord, Video Signal Cable, Remote Control, AA Battery x 2, Clamp x 3, Screw x 9, CD-ROM, Stand x 2, Thumbscrew for stand x 2, Cable cover

**NOTE:** Technical specifications are subject to change without notice.

\*: Compressed image

# Specifications - LCD4620

## Product Specifications

LCD Module		Pixel Pitch:	46" /116.8cm diagonal
		Resolution:	0.7455mm
		Colour:	1366 x 768 dots
		Brightness:	Over 16 million colours (depending on video card used)
		Contrast Ratio:	650cd/m <sup>2</sup> (Max.), 500cd/m <sup>2</sup> (Typ.)
		Viewing Angle:	1200:1
		Design View Distance:	Up 89°/ Down 89°/ Left 89°/ Right 89° (typ) @ CR>10 1300mm
Frequency	Horizontal:	15.625/15.734kHz, 31.5kHz - 91.1kHz (Analog Input) 31.5kHz - 91.1kHz (Digital Input)	
	Vertical:	50.0 - 85.0 Hz	
Pixel Clock	25.2MHz - 162.0MHz		
Viewable Size	1018.353 x 572.54mm		
Input Signal			
DVI	DVI-D 24pin	Digital RGB	DVI (HDCP) VGA60, SVGA60, XGA60, WXGA60, SXGA60, UXGA60*, 1920X1080* (60Hz)
VGA	15pin Mini D-sub	Analog RGB	0.7V p-p, Input Impedance 75 ohm VGA60, SVGA60, XGA60, WXGA60, SXGA60, UXGA60*, 1920X1080* (60Hz)
		Sync	Separate: TTL level (Pos./Neg.) Composite sync on Green Video: 0.3Vp-p Neg.
RGB/HV	BNC (R,G,B,H,V)	Analog RGB	0.7V p-p, Input Impedance 75 ohm VGA60, SVGA60, XGA60, WXGA60, SXGA60, UXGA60*, 1920X1080* (60Hz)
		Sync	Separate: TTL level (Pos./Neg.) Composite sync on Green Video: 0.3Vp-p Neg.
HDMI	HDMI Type-A	Digital RGB	HDMI 1080p*, 1080i*, 720p@50Hz/60Hz, 576p@50Hz, 480p@60Hz
DVD/HD	RCA (Y, Cb/Pb, Cr/Pr)	Component	Y : 1.0Vp-p/75ohm, Cb/Cr (Pb/Pr) : 0.7Vp-p/75 ohm HDTV/DVD:1080p*, 1080i*, 720p@50Hz/60Hz, 576p@50Hz, 480p@60Hz, 576i@50Hz, 480i@60Hz
VIDEO	BNC RCA	Composite	1.0V p-p Input Impedance 75 ohm NTSC/PAL/SECAM/4.43NTSC/PAL60
S-VIDEO	Mini DIN 4 pin	S-VIDEO	Y: 1.0Vp-p/75 ohm C: 0.286Vp-p/75 ohm (NTSC), 0.3Vp-p/75 ohm (PAL/SECAM) NTSC/PAL/SECAM/4.43NTSC/PAL60
Output Signal			
RGB/HV	BNC (R,G,B,H,V)	Analog RGB	Analog RGB Video: 0.7V p-p with 75 ohm terminated Separate HV sync: TTL level (Posi / Nega)
VIDEO	BNC	Composite	Composite 1.0V p-p with 75 ohm terminated
AUDIO			
AUDIO Input	RCA (L/R) X2 STEREO Mini Jack	Analog Audio	Stereo L/R 0.5Vrms
	HDMI Type-A	Digital Audio	PCM 32, 44.1, 48KHz (16/20/24bit)
AUDIO Output	STEREO Mini Jack	Analog Audio	STEREO Mini Jack L/R: 1, 0.5Vrms
Speaker Output	External Speaker Jack 15W + 15W (8 ohm)		
Control	RS-232C In:	9 Pin D-sub	
	RS-232C Out:	9 Pin D-sub (with daisy chain)	
TV	F-connector:	Antenna Impedance 75ohm	
	Channel Coverage:	VHF: E2 to E12/R1 to R12 UHF: E21 to E69 CATV: S1 to S41	
Power Supply	3.4 - 1.35 A @ 100-240VAC, 50/60Hz		
Operational Environment	Temperature:	5 - 40°C (Default brightness), 5 - 20°C (Max brightness)	
	Humidity:	20 - 80% (without condensation)	
Storage Environment	Temperature:	-20 - 60°C	
	Humidity:	10 - 90% (without condensation)/ 90% - 3.5% x (Temp - 40°C) regarding over 40°C	
Dimension	Net:	1055.4 (W) x 644.1 (H) x 351 (D) mm (with stand) 1055.4 (W) x 608.6 (H) x 140 (D) mm (without stand)	
	Gross:	1278 (W) x 837 (H) x 312 (D) mm	
Weight	Net:	37.9Kg (With stand), 36.1Kg (Without stand)	
	Gross:	47.1Kg	
VESA compatible arm mounting interface	3 x 200mm x 200mm (8 Holes) 2 x 200 mm x 200 mm (6 Holes)		
Complied Regulatory and Guidelines	UL60950-1/CSA C22.2 No.60950-1/ TUV-GS/EN60950-1/NOM FCC-B/DOC-B/EN55022-A/EN55024/EN61000-3-2/EN61000-3-3/CE/GOST-R		
Power Management	VESA DPM		
Plug & Play	VESA DDC2B, DDC/CI		
Accessories	User's manual, Power Cord, Video Signal Cable, Remote Control, AA Battery x 2, Clamp x 3, Screw x 9, CD-ROM, Stand x 2, Thumbscrew for stand x 2, Cable cover		

**NOTE:** Technical specifications are subject to change without notice.

\*: Compressed image

# Pin Assignment

## 1) Analog RGB input (MiniDsub15p): VGA

Pin No	Name
1	Video Signal Red
2	Video Signal Green
3	Video Signal Blue
4	GND
5	DDC-GND
6	Red-GND
7	Green-GND
8	Blue-GND
9	+5V (DDC)
10	SYNC-GND
11	GND
12	DDC-SDA
13	H-SYNC
14	V-SYNC
15	DDC-SCL

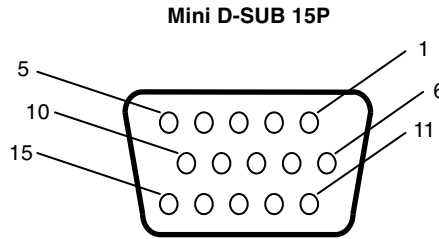

## 2) S-VIDEO input: VIDEO

Pin No	Name
1	GND
2	GND
3	Y (Luminance)
4	C (Chroma)

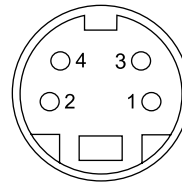

## 3) Digital RGB input (DVI-D): DVI

Pin - Assignment of DVI connector:					
1	TX2-	9	TX1-	17	TX0-
2	TX2+	10	TX1+	18	TX0+
3	Shield (TX2 / TX4)	11	Shield (TX1 / TX3)	19	Shield (TX0 / TX5)
4	NC	12	NC	20	NC
5	NC	13	NC	21	NC
6	DDC-Serial Clock	14	+5V power	22	Shield (TXC)
7	DDC-Serial Data	15	Ground	23	TXC+
8	NC	16	Hot plug detect	24	TXC-

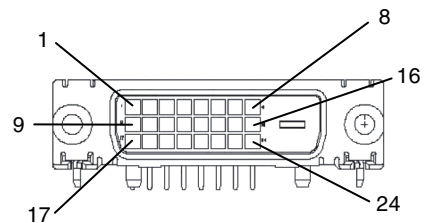

## 4) RS-232C input/output

Pin No	Name
1	connected to 7&8
2	RXD
3	TXD
4	connected to 6
5	GND
6	connected to 4
7	connected to 1&8
8	connected to 1&7
9	NC

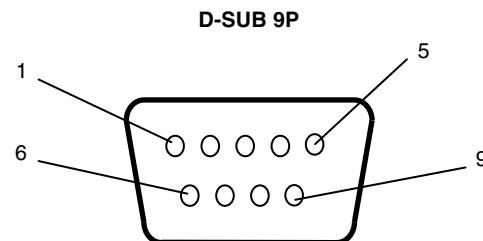

This LCD monitor uses RXD, TXD and GND lines for RS-232C control.



# Manufacturer's Recycling and Energy Information

NEC DISPLAY SOLUTIONS is strongly committed to environmental protection and sees recycling as one of the company's top priorities in trying to minimize the burden placed on the environment. We are engaged in developing environmentally-friendly products, and always strive to help define and comply with the latest independent standards from agencies such as ISO (International Organisation for Standardization) and TCO (Swedish Trades Union).

## Disposing of your old NEC product

The aim of recycling is to gain an environmental benefit by means of re-use, upgrading, reconditioning or reclamation of material. Dedicated recycling sites ensure that environmentally harmful components are properly handled and securely disposed. To ensure the best recycling of our products, **NEC DISPLAY SOLUTIONS offers a variety of recycling procedures** and gives advice on how to handle the product in an environmentally sensitive way, once it has reached the end of its life.

All required information concerning the disposal of the product and country-specific information on recycling facilities can be found on our following websites:

<http://www.nec-display-solutions.com/greencompany/> (in Europe),

<http://www.nec-display.com> (in Japan) or

<http://www.necdisplay.com> (in USA).

## Energy Saving

This monitor features an advanced energy saving capability. When a VESA Display Power Management Signalling (DPMS) Standard signal is sent to the monitor, the Energy Saving mode is activated. The monitor enters a single Energy Saving mode.

### LCD4020

Mode	Power consumption	LED colour
Normal Operation	Approx. 300W	Green
Energy Saving Mode	Less than 5W	Amber
Off Mode (ECO standby)	Less than 1W	Red

### LCD4620

Mode	Power consumption	LED colour
Normal Operation	Approx. 340W	Green
Energy Saving Mode	Less than 5W	Amber
Off Mode (ECO standby)	Less than 1W	Red

## WEEE Mark (European Directive 2002/96/EC)

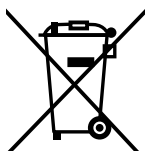

### Within the European Union

EU-wide legislation, as implemented in each Member State, requires that waste electrical and electronic products carrying the mark (left) must be disposed of separately from normal household waste. This includes monitors and electrical accessories, such as signal cables or power cords. When you need to dispose of your NEC display products, please follow the guidance of your local authority, or ask the shop where you purchased the product, or if applicable, follow any agreements made between yourself and NEC.

The mark on electrical and electronic products only applies to the current European Union Member States.

### Outside the European Union

If you wish to dispose of used electrical and electronic products outside the European Union, please contact your local authority so as to comply with the correct disposal method.