

# ***PS/PX/PC SERIES POWERSTATION***

## **User Guide**

***Parker Automation – CTC  
50 W. TechneCenter Drive, Milford, Ohio 45150***

***Phone: 513-831-2340  
Technical Support: 513-248-1714***

# Copyright and Trademark Notice

Copyright © 2003 by Parker Automation - CTC. All rights reserved. No part of this publication may be reproduced, transmitted, transcribed, stored in a retrieval system, in any form or by any means, mechanical, photocopying, recording or otherwise, without the prior written consent of Parker Automation - CTC.

While every precaution has been taken in preparing this manual, Parker Automation - CTC and the author assume no responsibility for errors or omissions. Neither is any liability assumed for damages resulting from the use of the information contained herein. All product and company names are trademarks of their respective companies and licenses.

## Product Warranty Information

Parker Automation - CTC provides top quality products through rigid testing and the highest quality control standards. However, should a problem occur with your hardware or with the software protection key, our standard product warranty covers these items for 15 months from the date of shipment. Exceptions appear below:

- Backlight bulbs have a 90-day warranty.
- Third-party products, such as bus cards, carry the manufacturer's specified warranty.
- For all displays, image retention (burn-in) is not covered by warranty.
- Software revisions that occur within 60 days after purchase are available, under warranty, upon request. Please review the software License Agreement for additional software warranty information.

If you have any questions about your application or need technical assistance, please check the Support page on the CTC website [www.ctcusa.com](http://www.ctcusa.com) or call Technical Support at 513-248-1714, 8:00 a.m. to 5:00 p.m., Eastern Time. You may call this same number after hours for emergency assistance. See *Customer Support Services on page 5* for more information about our support products and services.

## Product Usage Notice

The SOFTWARE and/or HARDWARE comprised as a PowerStation is not designed, manufactured, or intended for use or resale as online control equipment in hazardous environments requiring fail-safe performance, such as in the operation of nuclear facilities, aircraft navigation or communication systems, air traffic control, direct life support machines, or weapons systems, in which the failure of this technology could lead directly to death, personal injury, or severe physical or environmental damage.

# Table of Contents

<b>Chapter 1: Overview and Support Services</b> .....	<b>7</b>
What's in this User Guide? .....	8
Documentation Standards .....	9
Text Conventions .....	9
ISO Symbols .....	9
Customer Support Services .....	9
Technical Support .....	10
Training and New Business Development.....	10
Documentation.....	11
<b>Chapter 2: Introducing the PS/PX/PC Series PowerStation</b> .....	<b>12</b>
Hardware Overview .....	13
PS/PX/PC Series PowerStation Custom Model Numbers.....	13
Software Overview.....	15
CPU Card.....	17
BIOS .....	19
Displays .....	21
Display with Function Keypad.....	21
Drives.....	22
Compact Flash Slots.....	22
Hard Drive.....	24
CD-ROM or CD-R/W Drive .....	24
Floppy Drive.....	24
Drive Functions .....	25
Ports .....	26
Serial Ports .....	27
Parallel Port .....	29
PS/2 Ports.....	30
Ethernet Port.....	30
Video Port .....	30
USB Ports .....	31
Power Supply.....	31
Battery.....	31
Fuse .....	32
System Peripheral Devices.....	32
Watchdog Timer.....	32

PowerSmart.....	32
Expansion Slots .....	34
I/O Addresses and IRQs .....	35
I/O Addresses.....	35
IRQs .....	36
Memory .....	36
Memory Modules .....	36
Memory Map.....	37
Memory Guidelines .....	37
<b>Chapter 3: Installation .....</b>	<b>39</b>
Selecting a Location.....	40
Class I, Division 2 Guidelines.....	40
Environmental Guidelines .....	40
Electrical Guidelines .....	40
Temperature Guidelines.....	41
Enclosure Guidelines .....	41
Accessing Ports, Drives, and Other Controls.....	41
Mounting the System .....	42
Mounting the PowerStation with Function Keypad.....	42
Mounting the other PS/PX/PC models .....	42
Mounting the RS/RX/RC models.....	44
Connecting the RS/RX/RC Unit to a Monitor .....	45
Starting the System.....	46
Starting in Windows 98, 2000, or XP Pro.....	46
Starting in Windows NT or Embedded NT .....	46
Starting in Multiboot Systems.....	46
Starting in MS-DOS.....	47
<b>Chapter 4: Maintenance .....</b>	<b>49</b>
BIOS Setup .....	50
Configuring the Touchscreen and Serial Ports .....	51
Resetting Disk Boot Priority.....	54
Loading Default BIOS Settings.....	56
Removing the CTC Splash Screen .....	56
Reinstalling Software .....	57
Reinstalling Software on Systems Running Windows.....	58
Reinstalling PowerStation Software on Systems Running MS-DOS .....	68

Restoring a Compact FlashCard.....	71
Maintaining the Display on a PS/PX/PC .....	72
Cleaning the Display Screen .....	72
Reconfiguring the Touchscreen Driver .....	72
Recalibrating the Touchscreen .....	74
Performing Internal Maintenance .....	76
Replacing Components.....	76
Observing ESD Precautions .....	77
Opening and Closing the System .....	78
Adding Expansion Cards .....	83
Changing Jumper Settings .....	85
<b>Chapter 5: Troubleshooting .....</b>	<b>93</b>
Troubleshooting Instructions.....	94
Problems When Starting .....	95
Problems Signaled by PowerSmart .....	97
Problems with Displays.....	99
Problems with Touchscreens.....	99
Problems with Peripheral Devices .....	100
<b>Appendix A: Specifications.....</b>	<b>103</b>
Physical Specifications .....	104
PS/PX/PC Series PowerStation Specifications .....	104
Recommended SDRAM Manufacturers.....	106
Operating Systems Supported.....	106
Display Specifications .....	107
Environmental Specifications.....	108
Electrical Specifications .....	109
Testing Specifications .....	109
Faceplate Chemical Resistance .....	110
Agency Approvals.....	111
<b>Index.....</b>	<b>112</b>



# CHAPTER 1: OVERVIEW AND SUPPORT SERVICES

This chapter explains what is in this User Guide. It also describes the documentation standards used in the Guide and important customer support services.

## **Chapter Contents**

---

<i>What's in this User Guide?</i>	8
<i>Documentation Standards</i>	9
<i>Customer Support Services</i>	9
<i>Documentation</i>	11

## What's in this User Guide?

This Guide describes the following Parker Automation – CTC workstations and industrial PCs belonging to the PS/PX/PC Series PowerStation. Unless otherwise indicated, the information in this Guide applies to all of the computers listed below.

PowerStations	Industrial PCs
PS (Interact) PX (InteractX)	PC
RS* (Interact) RX* (InteractX)	RC*

\* = No display

The purpose of this Guide is to help you set up and use your PowerStation model PS, PX, PC, RS, RX, or RC. It describes your system and explains how to install your system, how to maintain it in good condition, and how to solve common operating problems.

In the Guide, you will find the following chapters:

Chapter	Title	Contents	Pg
1	<i>Overview and Support Services</i>	Overview of this Guide's contents, and CTC customer support services.	7
2	<i>Introducing the PS/PX/PC Series</i>	System functions and features, including cabling, pinout, and addressing information.	12
3	<i>Installation</i>	How to mount your system in an enclosure or on a panel and start it up.	39
4	<i>Maintenance and Troubleshooting</i>	How to maintain the system.	49
5	<i>Troubleshooting</i>	How to solve operational problems.	93
Appendix A	<i>Specifications</i>	Tables showing system specifications.	103





## Documentation Standards

This Guide uses the following standards.

### Text Conventions

Style	Type of Text
<b>Bold</b>	Names of buttons, tabs, menus, menu items, commands, files, keyboard keys, dialog boxes, and other important terms.
<b><i>Bold Italics</i></b>	Titles of User Guides, chapters, or sections, and linked cross-references.
Courier font	Text to be entered from a keyboard.
▶	Indicates multiple steps in selecting a particular menu command. For example, "In the Windows task bar, click <b>Start ▶ Settings ▶ Control Panel.</b> "
+	Indicates two or more keyboard keys that must be pressed simultaneously. For example, <b>Ctrl+Alt+Delete.</b>
<b>Note</b>	Alternative approaches or issues.
<b>Important</b>	Information that will save time and minimize problems.
<b>Warning</b>	Information that will prevent equipment damage or personal injury.

### ISO Symbols

Symbol	Meaning
	International Standards Organization (ISO) symbol for Caution (ISO 3864 No. B.3.1). Denotes activity that could affect operation of the computer if instructions are not followed.
	ISO symbol for Caution—risk of electrical shock (ISO 3864 No B.3.6). Denotes activity that could cause personal injury from electrical shock or damage to equipment if instructions are not followed.

## Customer Support Services

We welcome your thoughts and suggestions on our products and services. You can contact us by telephone, email, or fax. You can also visit Parker Automation - CTC on the World Wide Web to learn the latest about our hardware, software, and customer support services.

Customer Support	
<b>Telephone</b>	513-831-2340
<b>Technical Support</b>	513-248-1714
<b>Fax</b>	513-831-5042
<b>E-mail</b>	<a href="mailto:sales@ctcusa.com">sales@ctcusa.com</a>
	<a href="mailto:support@ctcusa.com">support@ctcusa.com</a>
	<a href="mailto:DocComments@ctcusa.com">DocComments@ctcusa.com</a>
<b>World Wide Web</b>	<a href="http://www.ctcusa.com">www.ctcusa.com</a>

We recognize that every customer and every application have different support needs, so we offer

four types of customer support services:

- Technical Support
- Training and New Business Development
- Documentation

## Technical Support

The Technical Support department welcomes your questions as you develop or run your applications. We offer complimentary support for any customer, whether you are an end-user, original equipment manufacturer (OEM), system integrator, or distributor.

If you have a question about your system, be sure to first:

- Check any release notes shipped with the system.
- Consult the documentation and other printed materials shipped with your system.
- Review Chapter 4: Maintenance and Chapter 5: Troubleshooting in this Guide.

If you cannot find a solution using one of the preceding sources:

- Call your CTC products distributor for support.
- View the Technical Support web page at [www.ctcusa.com](http://www.ctcusa.com) which contains answers to Frequently Asked Questions, application notes, product user guides, and software downloads that may be helpful.
- Call CTC Technical Support at 513-248-1714, 8:00 a.m. to 5:00 p.m., Eastern Time.

You can call CTC Technical Support after hours for emergency assistance.

## Training and New Business Development

Our Training and New Business Development department provides service in two areas: training and consulting.

### Training

We offer training on all of our products either at CTC Parker, in our state-of-the-art training center, or at your site. You can learn how to:

- Write custom interfaces
- Develop specialized applications
- Implement your complete operator interface application

To contact the Training Coordinator:

Training	
Telephone	1-800-233-3329
E-mail	<a href="mailto:training@ctcusa.com">training@ctcusa.com</a>

## Application Engineering Services

We offer consulting services through our Application Engineering Services group. Our Application Engineering group can build your application from the ground up:

- Write custom communications drivers
- Design special modules to perform functions unique to your application

Our specialists are flexible, so they can create a project development schedule that meets your needs. You can contact Application Engineering Services in one of the following ways:

Application Engineering	
Telephone	1-800-233-3329
E-mail	<a href="mailto:appeng@ctcusa.com">appeng@ctcusa.com</a>

## Documentation

You can download CTC product documentation from our Web site at [www.ctcusa.com](http://www.ctcusa.com) at the **Support** weblink under **Product Manuals**.

We also welcome your comments on this User Guide or any of our other documentation. Please email your comments to: [DocComments@ctcusa.com](mailto:DocComments@ctcusa.com)

# CHAPTER 2: INTRODUCING THE PS/PX/PC SERIES POWERSTATION

This chapter describes the features of the PS/PX/PC Series PowerStation including the display options, drives, and ports that link the system with other devices. It also describes system peripheral devices and the systems' expansion slots, I/O addresses, and memory.

## **Chapter Contents**

---

<i>Hardware Overview</i>	13
<i>Software Overview</i>	15
<i>CPU Card</i>	17
<i>BIOS</i>	19
<i>Displays</i>	21
<i>Drives</i>	22
<i>Ports</i>	26
<i>Power Supply</i>	31
<i>System Peripheral Devices</i>	32
<i>Expansion Slots</i>	34
<i>I/O Addresses and IRQs</i>	35
<i>Memory</i>	36

## Hardware Overview

The PowerStation includes models PS/PX/PC that come with a display and models RS/RX/RC that are remote systems.

---

**Note** For complete specifications on all systems, see *Appendix A: Specifications* on page 103.

---

The PS Series PowerStation workstations share the following features:

- External and Internal Compact Flash (CF) slots
- Optional hard drive, CD-ROM, CD-R/W drive, and floppy disk drives
- Three external serial ports (COM1, COM2, COM3)
- Parallel port
- Ethernet port
- Video port
- Two USB ports
- ISA/PCI Expansion (for certain models)
- Watchdog timer
- PowerSmart system monitor

There are differences among the systems in the following features:

- Touchscreen (remote systems do not have one)
- Sizes and types of displays used
- Types and quantity of expansion slots provided

---

**Note** For additional information about these systems and their displays, see the following: *Display Specifications* on page 107, and *Physical Specifications* on page 104.

---

### PS/PX/PC Series PowerStation Custom Model Numbers

The model numbers for the PowerStation follows the format **YYXX-Zd#-abc-efg**.

For the first 5 digits of the PowerStation model numbers (**YYXX-Zd#**), refer to the following tables.

For the last 6 digits of the PowerStation model numbers (**abc-efg**), refer to your price guide.

**YY** indicates the format of the model.

<b>PS Series PowerStation Format YYXX-Zd#</b>	
PowerStation (with Interact)	<b>PS</b>
PowerStation (with InteractX)	<b>PX</b>
Industrial PC	<b>PC</b>
Remote PowerStation (with Interact)	<b>RS</b>
Remote PowerStation (with InteractX)	<b>RX</b>
Remote Industrial PC	<b>RC</b>

**XX** indicates the display size.

<b>Screen Sizes YYXX-Zd#</b>	
No display	P_00
10 inch	P_10
10 inch with Function Keypad and Touchscreen	P_51
10 inch with Function Keypad and no Touchscreen	P_50
12 inch	P_12
15 inch	P_15
18 inch	P_18

---

**Note** Displays are available for the PS, PX, and PC workstation models only, not for the Remote workstations.

---

**-Z** indicates whether the workstation operates with PC/104 cards or ISA/PCI cards.

<b>Cards</b>	<b>YYXX-Zd#</b>
PC/104	YYXX-2
ISA/PCI (3/4 length)	YYXX-3
	YYXX-4
ISA/PCI (full length)	YYXX-5
	YYXX-6

**d** indicates the display type.

<b>Display Type</b>	<b>YYXX-Zd#</b>
Monochrome	M
TFT	T
Bright TFT	H
TFT SVGA	S

# indicates the processor type.

Processor Type	YYXX-Zd#
Pentium MMX 266MHz	2
Celeron 566MHz	4
Pentium III 1.0GHz	6

Following are the side views of some different models:

PS15-3

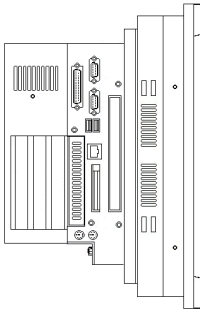

PS51-2

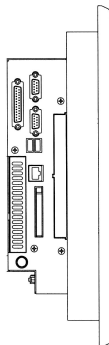

PS12-2

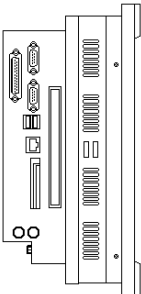

## Software Overview

Each PowerStation is pre-loaded with the software you have purchased. Backup copies of all installed software are provided on CDs and floppy disks in case you need to reinstall any of it.

The following table shows the software you will receive with your system. Descriptions of the software follow the table.

CD/Disk Name and Part Number	PS/RS/RX				PC/PX/RC				
	DOS	Windows			Windows				
		98	2000	NT	98	2000	NT	*E-NT	XP Pro
PS/PX/PC Documentation, Drivers, and Utilities CD DCD-1000	X	X	X	X	X	X	X	X	X
MachineShop CD S3-72931	X	X	X	X					
MS-DOS 6.22 and Utilities Installation Disk KA-72953	X		X	X					
Windows 98 OEM Packet B4-05916		X			X				
Windows 2000 OEM Packet B4-05990			X			X			
Win NT 4.0 Emergency Recovery Disk KA-72668				X			X		
Windows NT 4.0 OEM Packet B4-05092				X			X		
Embedded NT Emergency Recovery Disk KA-83441								X	
Windows XP OEM Packet									X

\*E-NT stands for Embedded NT

**PS/PX/PC Documentation, Drivers, and Utilities CD:** Contains system files, utilities, and most drivers for the PCs as well as the manual and engineering dimensional drawings.

**MachineShop CD:** Contains the complete installation of MachineShop Suite and Interact. Comes with an Installation Booklet.

**MS-DOS 6.22 and Utilities Installation Disk:** Contains the MS-DOS operating system and utilities.

**Windows 98 OEM Packet:** Contains the Windows 98 installation CD and other Microsoft materials.

**Windows 2000 OEM Packet:** Contains the Windows 2000 installation CD and other Microsoft materials.

**Win NT 4.0 Emergency Recovery Disk:** Contains files to start Windows NT 4.0 if the operating system is damaged. Shipped only with PCs running Windows NT 4.0.

**Windows NT 4.0 OEM Packet:** Contains the Windows NT 4.0 installation CD and other Microsoft materials.

**Win Embedded NT 4.0 Emergency Recovery Disk:** Contains files to start Windows Embedded NT 4.0 if the operating system is damaged. Shipped only with PCs running Windows Embedded NT 4.0.

**Windows XP OEM Packet:** Contains the Windows XP installation CD and other Microsoft materials.



## CPU Card

The PowerStation CPU uses a custom, small format form-factor.

The CPU card has the following characteristics:

Feature	Description
Size (H x W)	8.0" (203.2mm) x 10.65" (270.5mm)
Processor	Intel® Pentium MMX™ 266MHz Intel® Celeron™ 566MHz Intel® Pentium III™ 1GHz
Bus interfaces	<ul style="list-style-type: none"> <li>• ISA bus: 16-bit, 8MHz</li> <li>• PCI bus: 32-bit, 33MHz</li> </ul>
Configurable jumpers (for jumper locations, see page 86 or 89)	<ul style="list-style-type: none"> <li>• COM2</li> <li>• Ethernet port</li> <li>• CF master/slave (jumpers for internal and external CF)</li> <li>• CMOS jumper</li> </ul>
Connectors and Drives	<ul style="list-style-type: none"> <li>• External Video connector</li> <li>• Floppy Drive connector</li> <li>• Internal CF</li> <li>• External CF</li> <li>• Hard Drive option</li> <li>• CD-ROM or CD-R/W Drive option</li> <li>• USB port</li> </ul>

The following illustration shows the 266MHz CPU card and its important features:

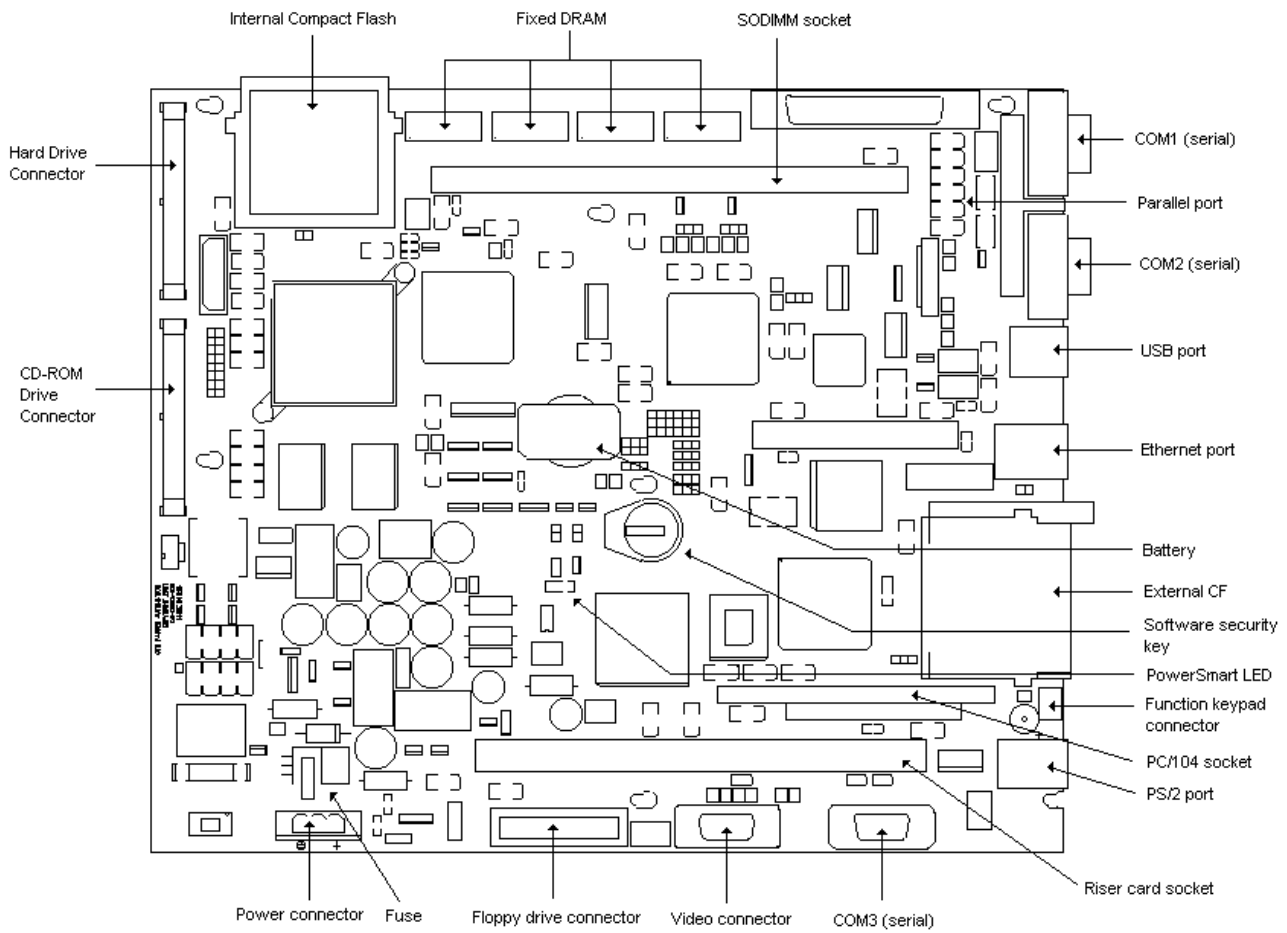

The following illustration shows the 566MHz and 1GHz CPU card and its important features:

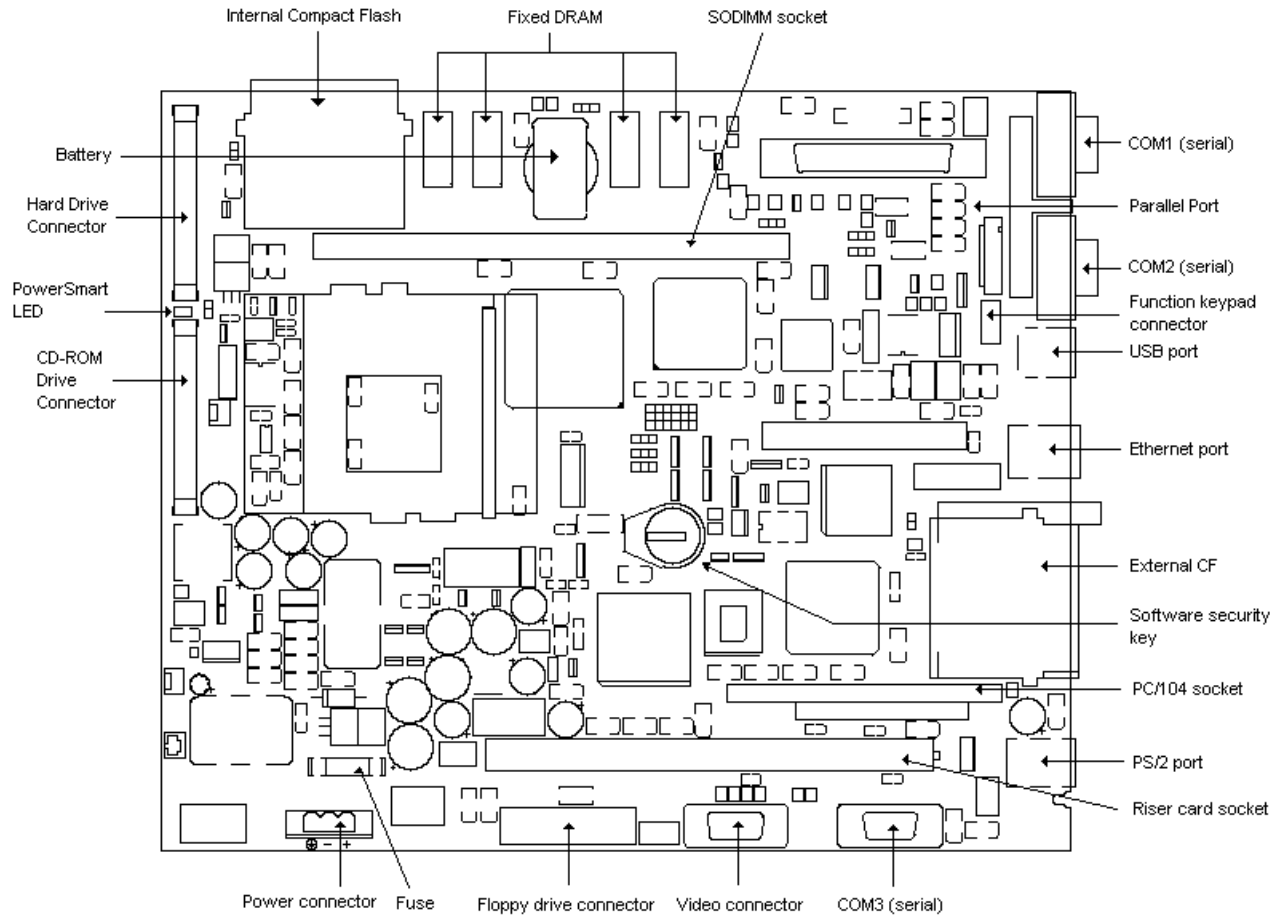

---

**Note** To see the locations of the workstation's configurable jumpers, see *Jumper locations* on page 85.

---

## BIOS

The PowerStation uses a Phoenix Basic Input Output System (BIOS), with 256K FLASH memory. The system BIOS performs two functions:

- It performs initialization tasks (testing and configuration of the system's standard components—e.g., video, system board RAM, floppy and fixed disks, serial and parallel ports, and other I/O devices) during its Power-on Self Test (POST).
- It provides application programs with a hardware-dependent software interface to system devices.

Standard BIOS features include the following:

- FLASH/EPROM-based setup utility
- POST

- Password protection
- System plug and play support
- Advanced power management

In addition, the system BIOS provides the following features:

- A Load Setup Defaults feature is provided so that you can re-establish the BIOS default settings if necessary.
- The “Sticky IDE” feature allows the BIOS to remember any IDE hardware that has ever been installed on the system, even if the hardware is currently not present.
- You can select I/O resources for the serial ports, touchscreen, and parallel port through menus in the BIOS CMOS setup.
- The video BIOS supports Video Electronics Standards Association (VESA) video modes.
- Jumpers select video BIOS support for each supported flat panel display, as well as for a CRT-only mode. These jumpers connect to I/O pins on the video controller, and the BIOS reads these connections at startup.
- When configured for flat panel displays, the BIOS provides analog video support simultaneously. When configured for CRT-only, the BIOS supports an analog multi-scan monitor.

The BIOS supports the following flat panel types.

Flat Panels Supported
1280 x 1024 color TFT
1024 x 768 color TFT
800 x 600 color TFT
640 x 480 color TFT
640 x 480 monochrome STN

- You can control flat panel brightness through menus in the BIOS CMOS setup.

---

**Note** This does not include the standard TFT display.

---

- The BIOS supports a startup “splash screen” that displays the CTC Parker logo. You can enable or disable this screen through a menu selection in the CMOS setup.

---

**Note** For additional information about the system BIOS, see *Physical Specifications* on page 104.

---

## Displays

The PS/PX/PC models support the displays shown in the following table:

PowerStation/PC	Size	Resolution	Color	Type
PS/PX	9.4"	VGA	Mono	STN
	10.4"	VGA	Color	TFT
	10.4"	VGA	Bright Color	TFT
	12.1"	SVGA	Color	TFT
	15.1"	XGA	Color	TFT
PC	10.4"	VGA	Color	TFT
	10.4"	SVGA	Color	TFT
	12.1"	SVGA	Color	TFT
	15.1"	XGA	Color	TFT
	18.1"	SXGA	Color	TFT

---

**Note** PowerStations with 12.1" and 15.1" displays have a special card installed that enables them to display Interact screens at 640 x 480 VGA resolution.

For additional display information, see also *Display Specifications* on page 107.

---

### Display with Function Keypad

The PowerStation models PS50/PC50 and PS51/PC51 include a display with a function keypad.

The function keypad includes 40 function keys: **F1** through **F20** and (using the **Shift** key) **F21** through **F40**. It also includes a programmable **Select** key. This section of the manual describes how to operate units equipped with function keys.

- **Function Keys**—allow you to send instructions to a software program. These instructions depend upon the software package you are using. For example, if you are using CTC Parker's Interact or InteractX software, you can assign a function key to each input tool on a panel.
- **Cursor Keys**—move the cursor around the screen. In Interact and InteractX, you can use the cursor keys to select options from menus.
- **Numeric Keypad**—contains keys for entering numeric data into the PowerStation.
- **Shift Key**—when active, allows you to access function keys **F21** through **F40**. This key is set to Momentary control by default. Momentary control provides access to **F21** through **F40** function keys whenever you press and hold the **Shift** key. When you release the **Shift** key, you automatically regain access to the **F1** through **F20** keys.

If you purchased Interact (not available with InteractX) with your PowerStation, you can also choose **Shift Lock** mode or **Shift Lock Release** mode.

- **Select Key**—generates a key scan code that is like pressing the **right Shift** key on a keyboard.

If you purchased Interact or InteractX with your PowerStation, you can change the operation

of this key to emulate any key.

---

**Note**      **Special Note for PS50/PC50 Users:** The **Select** key on the PowerStation has been preset to imitate the **right Shift** key. The shift mode of the unit is set for “momentary shift,” which means that you must hold down the **Shift** key while you press another key.

---

## Drives

The PS/PX/PC Series PowerStation is equipped with a variety of storage and read/write devices:

- External Compact Flash (CF) slot
- Internal Compact Flash slot
- Hard disk drive (optional)
- CD-ROM or CD-R/W drive (optional)
- External 3.5" floppy disk drive (optional)

These drives are described in this section.

### Compact Flash Slots

The PS/PX Series PowerStation has two Compact Flash slots to accommodate CF cards. Both slots support Type 1 or Type 2 CF cards.

The internal CF is located in the upper left corner of the CPU card (see the CPU card illustration on page 18). The internal CF is the primary master drive when no hard drive is installed and a primary slave drive when a hard drive is installed. For additional information on master/slave settings, see the *Internal CF master/slave status* on page 87 (266MHz CPU boards) or page 90 (566MHz/1GHz CPU boards).

The external CF is located at the left side of the unit, as shown in the following illustration. The external CF is the secondary master drive when no CD-ROM drive is installed. It is a secondary slave drive when a CD-ROM drive is installed. For additional information on master/slave settings, see the *External CF master/slave status* on page 88 (266MHz CPU boards) or page 91 (566MHz/1GHz CPU boards).

---

**Note**      CF cards are optional with the PC and the RC\RX models.

---

The following illustration shows the location of the CF Slot and CD-ROM or CD-R/W Drive on a PSXX-2.

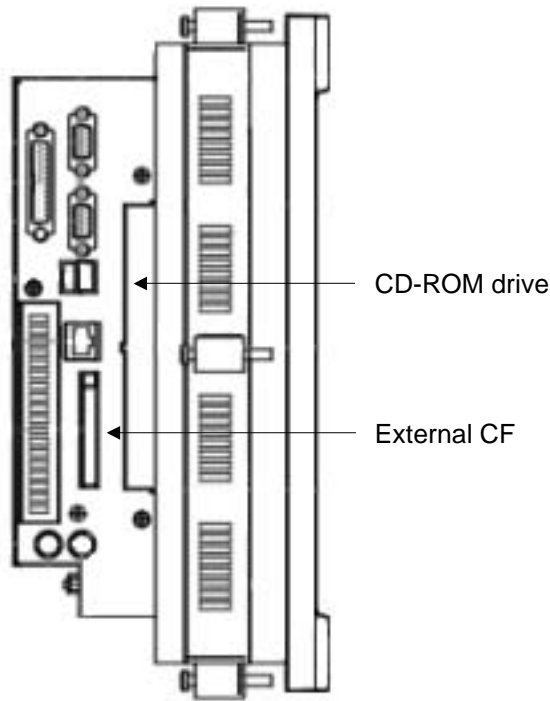

## Using CF cards

A CF card is like a removable hard drive and provides non-volatile storage memory. A CF card is often used as a supplement to, or a replacement for, a hard drive because a CF card is well suited to environments in which the unit may be vibrated or shaken.

---

**Note** You also can use a hard drive with no CF at all.

---

You can use a CF card as the startup drive or as a secondary IDE drive.

You can reformat a CF card or update the files on it. See *Restoring a Compact FlashCard* on page 71 for complete instructions.

---

**Important** Formatting flashcard in Windows NT and 2000 overwrites the systems files that make the flashcard bootable.

---

Uses for the CF card are as follows: Internal CF	External CF
Operating system	Operating system
Development and runtime software	Programs
May use with hard drive	May use with hard drive
	Projects and applications

If you purchased a CF card, we recommend that you purchase at least one additional card to serve as a backup. You may wish to have several cards on hand to store different projects. To purchase additional CF cards, call your local distributor.

## Removing and replacing CF cards

To remove and replace an external CF card, complete the following steps:

1. Shut down the Operating System.
2. Turn off the system.



### Warning

Always make sure that the system is turned off when inserting or removing a CF card.

3. Press the eject button next to the external CF slot, and remove the card by sliding it out of its slot toward you.
4. Reinstall the CF card by carefully inserting it into its slot and pushing it into the slot until the card is securely seated (the eject button should pop out).



### Important

When inserting a CF card, align the arrow on the card with the arrow that appears over the CF slot.

---

## Hard Drive

The PS/PX Series PowerStation has an optional internal hard disk drive for storing system software, projects, and applications.

## CD-ROM or CD-R/W Drive

The PS/PX Series PowerStation has an optional CD-ROM or CD-R/W drive, located on the left side of the unit (see the illustration on page 23). The CD-ROM drive can be used to read files or load and run software. In addition, the CD-R/W drive can be used to log or record data.

## Floppy Drive

The PS/PX Series PowerStation has an external, 3.5", 1.44MB floppy drive connector. You can connect an optional external 3.5", 1.44MB floppy drive to this connector, and the drive can be mounted on a panel or desktop, or fastened to the back of the unit.

### Floppy Drive Connector

You can purchase a floppy drive cable from CTC Parker Automation. If you need to make a cable to connect the floppy drive to the PowerStation PS, the pinout information for the floppy drive connector is shown in the following table.

Pin #	Signal Name	Pin #	Signal Name
1	+5VDC	14	WRDATA#
2	INDX#	15	GND
3	+5VDC	16	WGATE#
4	REDWC#	17	GND
5	+5VDC	18	TRKO#



Pin #	Signal Name	Pin #	Signal Name
6	MOTEA#	19	GND
7	GND	20	WPT#
8	DRUSA#	21	GND
9	GND	22	RDDATA#
10	DIR#	23	GND
11	GND	24	SIDE1#
12	STEP#	25	GND
13	GND	26	DSKCHG#

## Drive Functions

The following table summarizes functions of the drives on the PS/PX Series PowerStation.

**Note** Letters used to define the drives (A, C, D, etc.) will depend upon which drives are installed on your system.

Drive Type	Size	Use
Internal Compact Flash (CF) card	16, 32, 128, 256, or 512MB	Primary master drive when no hard drive is installed; primary slave drive when a hard drive is installed. May store the operating system, and development and runtime software. Download files to this drive only if its size is sufficient.
External Compact Flash (CF) card	16, 32, 128, 256, or 512MB	Secondary master drive when no CD-ROM drive is installed. Secondary slave drive when a CD-ROM drive is installed. May store projects and applications. Download files to this drive only if its size is sufficient.
3.5" Floppy drive (optional, external)	1.44MB	May be used to install software or save files. Use it to download projects to the unit and back up files.
Hard drive (optional)	10GB or higher.	Primary master drive when installed. Stores the operating system, development and runtime software, projects, and applications.
CD-ROM or CD-R/W drive (optional)		Secondary master drive when installed. May be used to install operating systems or other software.

**Note** The internal and external Compact Flash and the CD-ROM drive are configured as masters or slaves with jumpers. See page 87 through 91 for instructions about how to set the jumpers properly.

## Ports

---

**Important** To be compliant with CE EMC emission requirements under EN55011, all video, serial, and parallel port communication cables must be 100% braided shielded cable.

---

The PS/PX Series PowerStation has the following ports:

- Three 16C550-compatible external serial ports
- One standard parallel port, supports Standard Parallel Port (SPP), Enhanced Parallel Port (EPP), and Enhanced Capability Port (ECP) standards
- Two PS/2 ports (one each for mouse and keyboard).
- One 10/100 Base-T Ethernet port
- One analog video port
- Two USB ports.

The following illustrations show the location of these ports; the sections that follow explain the ports' uses and give pinout information.

---

**Note** The following illustrate a PXXX-2 model. However, the ports are located in the same location on all models.

---

### Ports: Side View

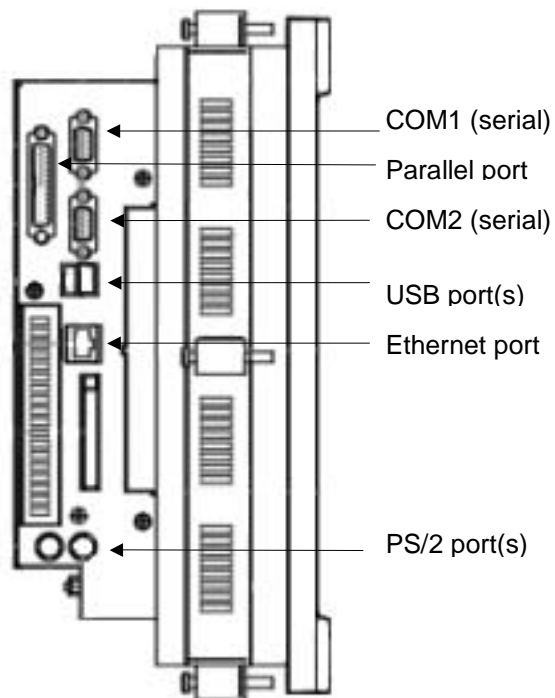

**Note** On a PowerStation with the function keypad (PX50, PX51), the keyboard connector is located on the back of the unit.

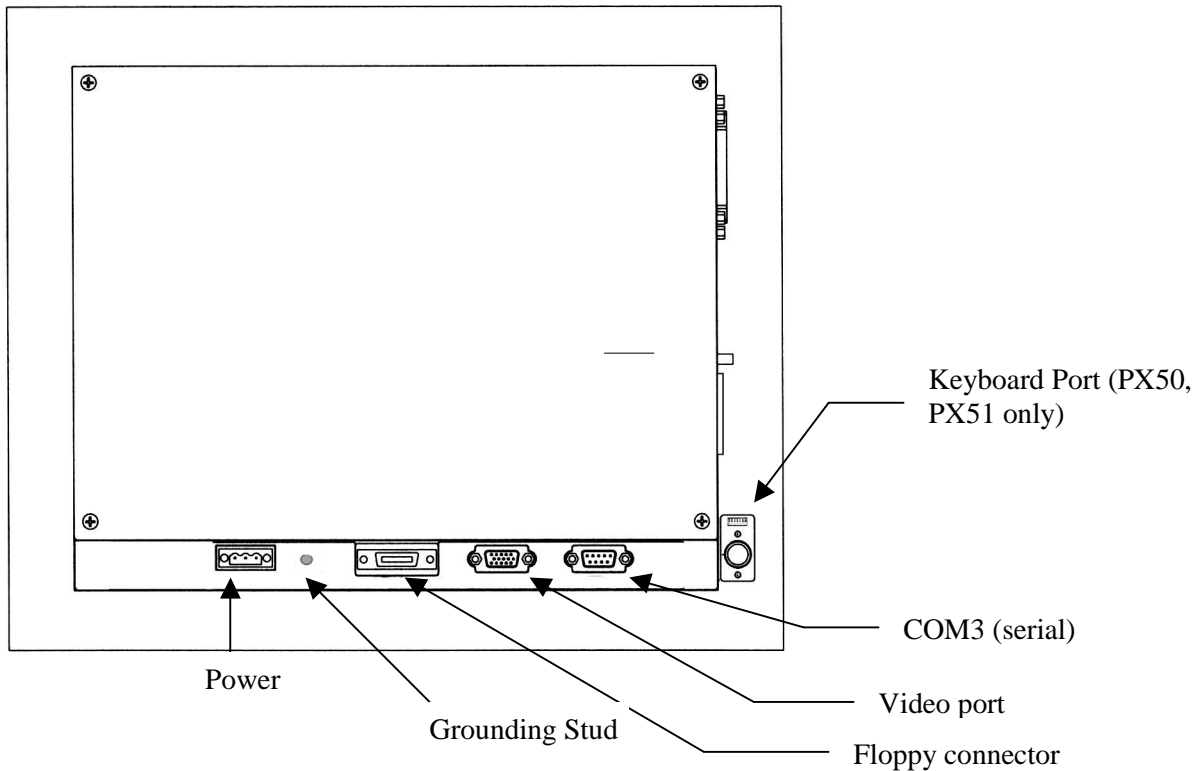
**Ports: Back View****Serial Ports**

The PS/PX Series PowerStation has three external serial ports:

- These ports are identified as COM1, COM2, and COM3.
- COM1 and COM2 are located on the left side of the unit; COM3 is located at the back of the unit.
- All three ports use standard, 9-pin, Male, D-sub connectors.

Communication standards for these ports are shown in the following table.

Port	Communication Protocol
COM1 COM3	RS-232
COM2	Default protocol (as shipped) is RS-485 Configurable for RS-232, RS-422, and RS-485

---

**Note** The system's touchscreen connector, located on the CPU card, is an internal serial controller designated as COM4.

---

When configuring COM2 for connection with a programmable logic controller (PLC), the communication standard you select for COM2 depends upon the distance between the system and the controller, as well as the communication standards that the controller supports:

- If you are using RS-232 communications, the length of the serial cable should not exceed 50

feet (15 meters).

- RS-422 and RS-485 communications offer greater noise immunity than RS-232 and increase the maximum cable length to 4,000 feet (1,200 meters).
- RS-422 communications are full-duplex (can send and receive simultaneously).
- RS-485 communications are half-duplex (can only send or receive at one time).
- For information on the specific connections required for Interact, InteractX, or MachineLogic drivers, look in the Help file associated with the driver.

For instructions on how to reconfigure COM2 for the RS-232, RS-422, or RS-485 protocol, see **COM2 communication protocol** on page 87 (266MHz CPU boards) or page 90 (566MHz/1GHz CPU boards).

### COM1, 2, and 3 pinouts

If you need to make a cable for communicating with COM1, COM2, or COM3, the pinout and signal information for these ports is shown below.

**Note** Remember, COM2 is configurable for RS-232, RS-422, and RS-485; its default setting is RS-485.

Pin #	RS-232 (COM1, 3 default)	RS-422	RS-485 (COM2 default)
1	DCD, data carrier detect	TX-, transmitted data -	TX-, transmitted data -
2	RX, received data	TX+, transmitted data +	TX+, transmitted data +
3	TX, transmitted data	RX+, received data +	RX+, received data +
4	DTR, data terminal ready	RX-, received data -	RX-, received data -
5	GND, signal ground	GND, signal ground	GND, signal ground
6	DSR, data set ready	DSR, data set ready	DSR, data set ready
7	RTS, request to send	RTS, request to send	RTS, request to send
8	CTS, clear to send	CTS, clear to send	CTS, clear to send
9	RI, ring indicator	RI, ring indicator	RI, ring indicator

The following illustration shows the cable diagrams for the RS-232, RS-422, and RS-485 protocols.

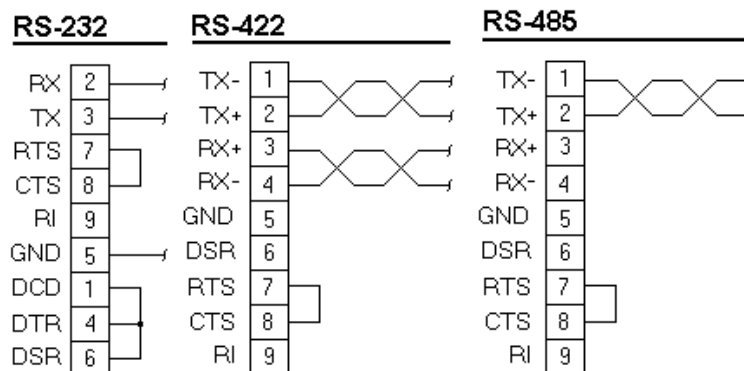

## Connecting to a PC

If you want to transfer files via serial connection from another PC to a PS Series PowerStation model, connect a serial cable with a null modem between available serial ports on each system. If you need to construct your own cables, refer to the following diagrams.

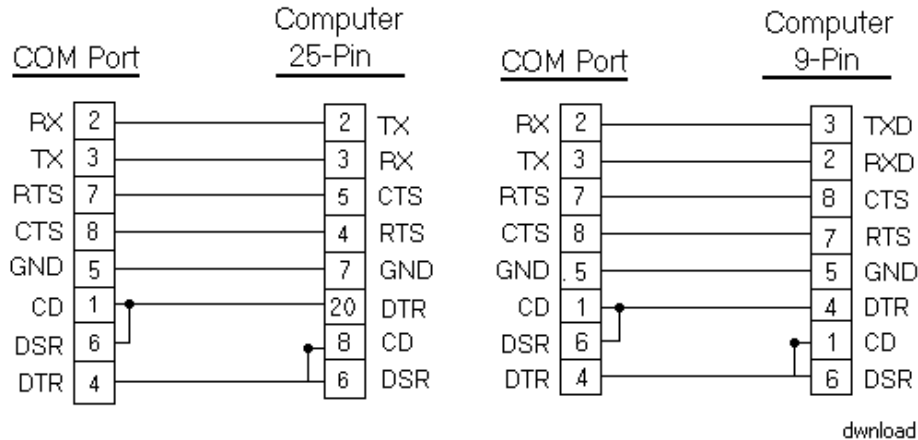

### Important

Be careful not to connect any wires to unused connector pins.

## Parallel Port

All workstation models in the PS/PX Series have one parallel port, located on the left side of the unit (see the illustration on page 26).

Pinout data for the parallel port is shown below.

Pin #	Signal Name	Pin #	Signal Name
1	STB (- Strobe)	10	ACK (- Acknowledge)
2	PD0 (+ Data Bit 0)	11	BUSY (+ Busy)
3	PD1 (+ Data Bit 1)	12	PE (+ Paper End)
4	PD2 (+ Data Bit 2)	13	SLCT (+ Select)
5	PD3 (+ Data Bit 3)	14	AFD (- Auto Feed)
6	PD4 (+ Data Bit 4)	15	ERR (- Error)
7	PD5 (+ Data Bit 5)	16	INIT (- Initialize Printer)
8	PD6 (+ Data Bit 6)	17	SLIN (- Select Input)
9	PD7 (+ Data Bit 7)	18-25	GND (Ground)

The PS/PX Series PowerStation can interface with any parallel printer designed for use with PCs. Connect a printer to the parallel port, using a standard PC parallel cable.

## PS/2 Ports

All PS/PX Series PowerStations have two PS/2 ports—one to connect a keyboard to the system and the other to connect a mouse. On most PS/PX Series models, the PS/2 ports are located at the left side of the unit (see the illustration on page 26).

---

**Note** The PowerStations with Function Keypad models (PX50, PX51) have one PS/2 port for the mouse at the left side of the unit and one PS/2 port for the keyboard at the back of the faceplate.

---

Pinout data for PS/2 ports is shown below.

Pin	Signal Name	Pin	Signal Name
1	Data	4	+5V (Fused)
2	NC	5	Clock
3	GND	6	NC

## Ethernet Port

The PS/PX Series PowerStation has an Ethernet RJ-45 port that allows you to connect the unit to a local area network (LAN) (see the illustration on page 26).

This port uses an Intel 82559 10/100 Mbps PCI Fast Ethernet controller with an integrated IEEE 802.3 10Base-T and 100Base-TX interface.

Pinout data for this port is shown below.

Pin#	Signal	Pin#	Signal
1	TX+	5	75 Ohm Terminator
2	TX-	6	RX-
3	RX+	7	75 Ohm Terminator
4	75 Ohm Terminator	8	75 Ohm Terminator

## Video Port

A dedicated video port is located at the back of the units that have the standard CPU board (see the illustration on page 27).

The video port has 2MB (4MB on 566MHz and 1GHz CPU boards) of embedded video memory, arranged in a 64-bit configuration.

The system's video output supports monochrome and high-resolution color displays.

---

**Note** For complete display specifications, see *Display Specifications* on page 107.

---

Pinout data for the video port is shown below.

Pin	Signal Name	Pin	Signal Name
1	ROUT	10	GND
2	GOUT	11	NC
3	BOUT	12	DDC data

Pin	Signal Name	Pin	Signal Name
4	NC	13	H_SYNHC
5-8	GND	14	V_SYNC
9	+5v (FUSED)	15	DDC Clock

## USB Ports

Two external USB ports are located at the left side of the unit with the standard CPU board (see the illustration on page 26).

- Each port can support one peripheral device.
- If you want to connect more than two USB devices, connect an external hub to either port in order to ensure that all devices receive an adequate signal.
- Self-identifying peripherals can be plugged in while the system is running.
- The system has automatic mapping of function to driver and configuration. Pinout data for the two USB ports is shown in the following table.

Pin #	Signal Name
1	Vcc
2	-Data
3	+Data
4	GND

## Power Supply

The PS/PX Series PowerStation is powered by 24VDC @ 5.00A(maximum). The input voltage range is 18VDC-28VDC. All system voltages, such as +/-5V, +/-12V, 3.3V, and CPU voltages are generated on the CPU card from the 24VDC input voltage.

The power supply is designed to protect against:

- Misapplication of 120VAC to the DC input connector
- Damage caused by reverse polarity DC input connections

In either case, the extent of damage to the electronics would be limited to blowing the input fuse.

For information about the fuse, see *Fuse* below. For more information about the PS/PX Series PowerStation power supply, see *Testing Specifications* on page 109.

## Battery

The PS/PX Series PowerStation uses a 3.0V, socket battery for real-time clock backup and CMOS storage. The battery is located on the CPU card (see the illustration on page 18 or 19) and is replaceable with a standard CR2032 battery.



### Caution

For units with replaceable Lithium batteries:

- There is danger of explosion if the battery is incorrectly replaced.
  - Replace the battery only with the same type of battery or an equivalent type recommended by the manufacturer.
  - Dispose of used batteries according to the manufacturer's instructions.
- 

## Fuse

The PS/PX Series PowerStation has an 8A (5A on 266MHz CPU card) fuse located on the CPU card (see the illustration on page 18 or 19). The fuse is a 250VAC Littelfuse, part #216.008 (part #216.315 on 266MHz CPU card). It is field replaceable by the same model fuse or its equivalent.

---

**Important** All fuses are intended for replacement by qualified service personnel only.

---

## System Peripheral Devices

System peripheral devices in the PS/PX Series PowerStation include the watchdog timer and the PowerSmart system monitor.

### Watchdog Timer

The PS/PX Series PowerStation's CPU card supports a watchdog timer. If the processor does not read or write to the timer register within 1.6 seconds, the timer will reset the computer.

The watchdog timer is configurable within CTC's Interact and InteractX software. If you are a user of one of these products and want to learn how to configure the watchdog timer, open the online help, and search on *watchdog timer*.

### PowerSmart

The PS/PX Series PowerStation comes with a PowerSmart system monitor that continuously monitors the following on a system:

- Five internal power supply voltages
- Internal temperature
- Total hours that the system has been in operation
- Communication errors in system monitoring devices
- System and CPU cooling fans, if installed

---

**Note** The Internal Temperatures window displays temperature data for the last 24 hours. To see more precise readings for temperature and time, use a mouse to move the small, white zoom arrows in the window.

---

On systems running Windows 98, 2000, NT 4.0, Embedded NT 4.0, or XP Pro PowerSmart appears as a graphical display, shown in the following illustration. Activate this display by clicking the PowerSmart icon on the Windows desktop



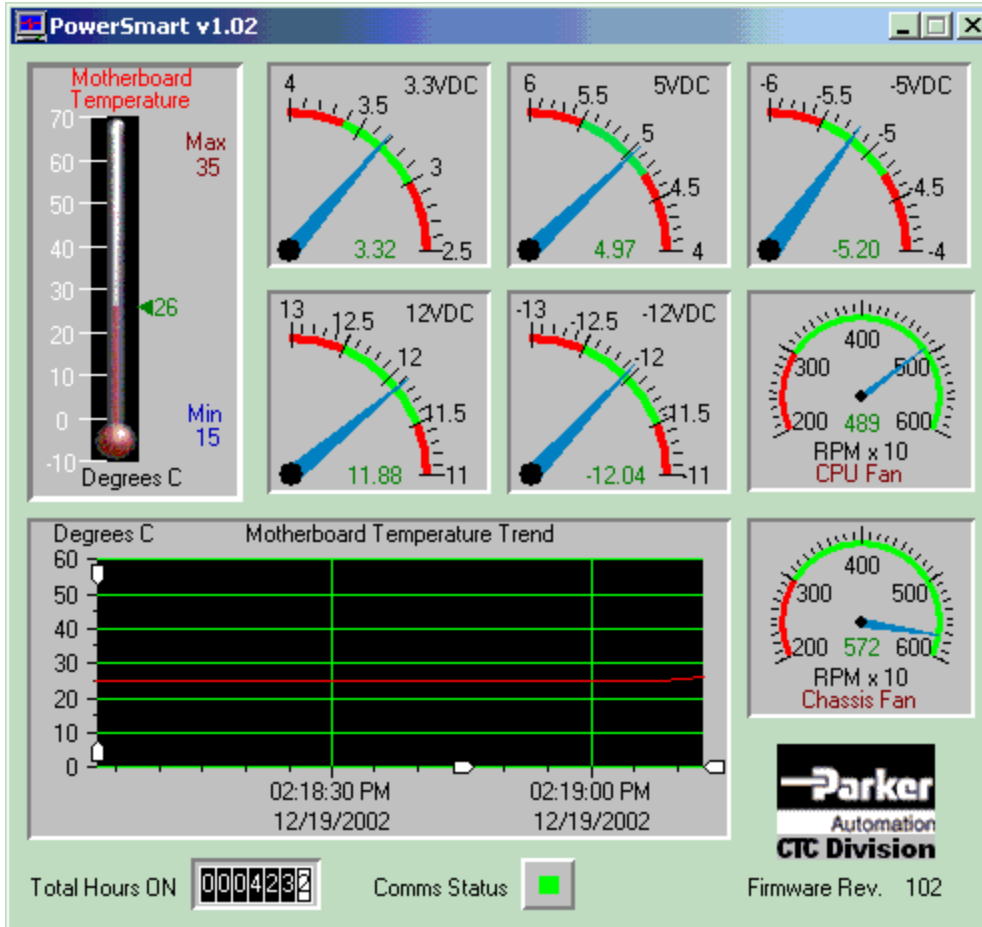

On systems running MS-DOS, you can access a text-based version of this display by typing **Pwrsmrt.exe** at the DOS prompt and then pressing **ENTER**.

Under Windows or MS-DOS, PowerSmart continually monitors the system regardless of whether the displays are shown.

**If any system parameters are out-of-limit:**

- The PowerSmart display will change color, and the gauges will show the error condition.
- If the display has been minimized, the PowerSmart button on the Windows taskbar will flash continually. Click on the button to show the display.

**If communication errors occur in system monitoring devices:**

- The Comms Status light (left of center in the display) will change from green to red.
- A dialog box will appear describing the problem. See *Problems Signaled by PowerSmart* on page 97 for suggestions about how to respond to error conditions.

To perform its functions, PowerSmart uses the I2C devices shown below. All devices are connected on a two-wire SMBus.

PowerSmart I2C Device	Location (266MHz board)	Location (566MHz/1GHz board)	Function
MicroController (87LPC764)	CPU card U38	CPU card U23	Programs and monitors all other peripheral devices on the bus. Determines the presence of error conditions. Logs error counts, temperature extremes, and hours of operation. Communicates error and status information to the SMBus host interface.
Peripheral monitor (DS1780)	CPU card U41	CPU card U37	Monitors power supply voltages and temperature.
EEPROM (24C02)	CPU card U39	CPU card U21	Stores error counts, temperature extremes, operation hours, and system configuration information.

## Expansion Slots

The maximum depth for all expansion slots is 11”.

Both the PSXX-3, -4, -5, and PSXX-6 models use a riser card that attaches to the standard CPU card (for the riser card socket location, see the illustration on page 18 or 19). Hold down brackets are available for the ISA and PCI cards to prevent the expansion cards from moving in environments where vibration occurs.

Expansion options are shown in the following table:

Model	Expansion Slots
PS/PX/PC/RS/RX/RCXX-2	Up to three PC/104 cards are supported
PS/PX/PC/RS/RX/RCXX-3 ISA majority (3/4 length slots)	Three 16-bit ISA <i>or</i> Two 16-bit ISA and one PCI <i>plus</i> One PC/104
PS/PX/PC/RS/RX/RCXX-4 PCI majority (3/4 length slots)	Three 32-bit PCI <i>or</i> Two 32-bit PCI and one 16-bit ISA <i>plus</i> One PC/104
PS/PX/PC/RS/RX/RCXX-5 ISA majority (full length slots)	Three 16-bit ISA <i>or</i> Two 16-bit ISA and one PCI <i>plus</i> One PC/104
PS/PX/PC/RS/RX/RCXX-6 PCI majority (full length slots)	Three 32-bit PCI <i>or</i> Two 32-bit PCI and one 16-bit ISA <i>plus</i> One PC/104

## I/O Addresses and IRQs

This section describes the I/O addresses and IRQs used by the PS/PX Series PowerStation.

### I/O Addresses

The following table shows the I/O addresses used by the PS/PX Series PowerStation. Make sure that any adapter cards you install do not conflict with these addresses.

Address	Function
0000-000F	DMA controller 1
0020-0021	Interrupt controller 1
0040-0043	Counter timer 1
0048-004B	Counter timer 2
0060/0062	Keyboard, NMI, speaker
0061/0063	Watchdog timer
0070-0071	Real time clock/NMI mask
0080-008F	DMA page register, POST checkpoint
00A0-00A1	Interrupt Controller 2
00C0-00DE	DMA Controller 2
00F0-00FF	Numeric co-processor
0170-0177	Secondary IDE channel
01F0-01F7	Primary IDE channel
0278-02FF	Parallel port 2 (CTC software security key)
02E8-02EF	Serial port 4 (default)
02F8-02FF	Serial port 2 (default)
0376	Secondary IDE port
0377	Floppy channel 2 command
0377 bit 7	Floppy disk change, channel 2
0377 bit 0:6	Secondary IDE channel status port
0378-037F	Parallel port 1 (default)
03BC-03BF	Parallel port 3 (opt)
03E8-03EF	Serial port 3 (default)
03F0-03F5	Floppy channel
03F6-03F7	Primary IDE and floppy
03F8-03FF	Serial port 1 (default)
04D0-04D1	Edge/level interrupts
0CF8-0CFF	PCI configuration

## IRQs

The PS/PX Series PowerStation configures IRQs as shown below.

IRQ	Default	Option
NMI	Parity/System errors	
0	System timer	
1	Keyboard	
2	Cascade for IRQ 8-15	
3	COM2	
4	COM1	
5	Reserved for user	
6	Floppy controller	
7	Parallel port 1	Available
8	Real-time clock	
9	COM3	
10	Reserved for user	
11	Touch screen	COM3
12	Reserved/PS/2 mouse	
13	Co-processor	
14	Primary IDE	
15	Reserved	Secondary IDE

If you choose to change IRQ settings, keep the following in mind:

- Any IRQ designated as “Reserved for user” can be taken by the PCI Ethernet adapter, which is a plug and play device.
- To see which IRQ the Ethernet adapter is using in systems running under Windows,
  - Click the **System** icon on the **Windows Control Panel** (or Right-click the **My Computer** Icon and select **Properties**)
  - Then select the **Hardware** Tab and select **Device Manager ► Network Adapters**
  - Right-click the individual network adapter(s) and check the **Properties** to find the IRQ settings.

## Memory

This section describes the SDRAM available in the PS/PX Series PowerStation, the way in which the PowerStation allocates memory, and memory guidelines for Interact and InteractX software users.

### Memory Modules

The PS/PX Series PowerStation comes with 64MB (32MB on 266MHz CPU cards) of SDRAM soldered onto the CPU card in four 16MB (8MB on 266MHz CPU cards) chips. In addition, a single

socket on the CPU card can accommodate up to 256MB of SDRAM. Maximum total memory supported by the CPU card is 512MB (256MB on 266MHz CPU cards).

---

**Note** A minimum of 128MB of memory is recommended for systems running Windows 2000. For additional information about the PS/PX Series PowerStation' memory, see *Physical Specifications* on page 104.  
If you need to replace memory modules, see the table of *Recommended SDRAM Manufacturers* on page 106.

---

## Memory Map

The following table shows how the PS/PX Series PowerStation allocates conventional and extended memory. Available address references are listed next to each device.

Function	Address Range (decimal)	Address Range (hex)	Size
Extended memory	1024K-524288K	100000-20000000	511MB
Boot block	1008K-1024K	FC000-FFFFF	16KB
ESCD (plug and play configuration area)	1000K-1008K	FA000-FBFF	8KB
Phoenix system BIOS	896K-1000K	E0000-F9FF	104KB
Available upper memory (open to ISA and PCI buses)	800K-896K	C8000-DFFFF	96KB
Video memory and BIOS	640K-800K	A0000-C7FFF	160KB
Conventional memory	0K-640K	00000-9FFFF	640KB

## Memory Guidelines

If using InteractX software, refer to your InteractX Getting Started Guide for information on Development and Runtime System Requirements.

If you are using Interact or MachineLogic software, follow the memory guidelines listed in the table below. If you are not using Interact or MachineLogic, you can skip this section.

Memory Type	Runtime	Development
System SDRAM	32MB min. of system memory	32MB of system memory required
Compact Flash (contains both Internal and external CF)		8MB external Compact Flash can store APM, AMM, GMM, and PTM, plus four additional runtime modules, two drivers, and approximately thirty screens. Extra modules require greater storage capacity (four modules/MB). Up to 1MB is needed to store MachineLogic applications. Log data to the CF only if its size is sufficient or if you are using the CF in conjunction with a hard drive.

<b>Memory Type</b>	<b>Runtime</b>	<b>Development</b>
Hard drive (optional)	Can store applications and logged data.	Can store any application. 50MB is needed for the MachineShop development suite (toolbar, Interact, and MachineLogic). 10MB is needed for the toolbar alone.
Floppy drive (optional, external)	Can be used to store logged data.	Can store most applications.

# CHAPTER 3: INSTALLATION

This chapter provides guidelines for selecting an appropriate location for the PS/PX/PC Series PowerStation. It also gives instructions for mounting the system in an enclosure (or on a panel if you have an RS/RX/RC system) and starting the system.

## **Chapter Contents**

---

<i>Selecting a Location</i>	40
<i>Mounting the System</i>	42
<i>Starting the System</i>	46

## Selecting a Location

The first step in installing your model is to select an appropriate location. This is the most important aspect of installation because the location you select will affect the system's performance, ease-of-use, and life expectancy. This section provides guidelines to follow when selecting a location.

### Class I, Division 2 Guidelines

If you purchased a Class I, Division 2-compliant computer, always follow these guidelines in order to maintain a safe operating environment:

- The computer is suitable for use in Class I, Division 2, Groups A, B, C, and D hazardous locations only.



**Warning**

**Explosion Hazard**—Do not disconnect equipment or replace or insert cards unless power has been switched off, or the area is known to be non-hazardous.



**Warning**

**Explosion Hazard**—Substitution of components may impair suitability for Class 1, Division 2.

- 
- If you are using AC power and mounted a CTC Parker AC adapter on your computer, make sure that the power cord is secured to the computer using the supplied L-bracket.

### Environmental Guidelines

The environment is the area where the system will be located.



**Caution**

In general, select a place that limits the system's exposure to adverse conditions, such as dust, oil, moisture, and corrosive vapors.

---

### Faceplate considerations

The faceplate is designed for a Type 4/4X environment. The system's faceplate is resistant to a variety of chemicals. See *Faceplate Chemical Resistance* on page 110 for a complete list.

---

**Important** The system is only rated for NEMA 4 when it is installed in a UL listed NEMA 4X enclosure

---

### Electrical Guidelines

---

**Important** Use the PowerStation ground stud to connect the unit to a suitable ground reference, such as earth ground or building steel. This ensures the unit is in compliance with immunity and emissions requirements necessary for proper operation.

---

To minimize unwanted electrical interference, select a location away from machinery that produces intense electrical noise (arc welders, for example).



If you cannot avoid electrical noise, isolate input power to the system, and separate all data communication cables from power lines.

---

**Important** In order to comply with UL 508 and 1604 requirements, use copper wire with 60C or 60/75C insulation and a tightening torque of 7.0 lb./in. (0.79 N-m) when connecting field terminal wiring to the system.

To comply with UL 60950 requirements for permanently connected equipment, a readily accessible disconnect device shall be incorporated in the building installation wiring.

---

The PS/PX/PC Series PowerStation accepts DC input only. To apply AC power, you must use an AC adapter.

---

**Note** You can purchase an AC adapter from your local distributor.

---

Make sure that your power source is completely compatible with the system before starting up. See *page 109* for a list of the system's Electrical Specifications)

## Temperature Guidelines

You should safely operate the system within the temperature range specified in the *Environmental Specifications* on page 108.

---

**Warning** If the system is operating inside an enclosure at temperatures above its rated ambient temperature, you must cool the enclosure.

---

## Enclosure Guidelines

Select an enclosure that is large enough to allow free airflow in and around the system.

Refer to your PS/PX/PC Documentation, Drivers, and Utilities CD for dimensional drawings that list the measurements you will need to mount your system. These include the unit's height, width, and depth; and location measurements for drives, ports, and controls.

- Allow a minimum of 2 inches around the unit for airflow.
- If you have a CD-ROM or CD-R/W drive, allow at least 3.5" between the enclosure and the left side of the unit so that the drive tray can open.

See *Accessing Ports, Drives, and Other Controls* below for additional guidelines.

Make sure that the surface where the unit will meet the front panel of the enclosure is flat in order to ensure a NEMA seal.

## Accessing Ports, Drives, and Other Controls

As shown in the illustration on page 26 or 27, two of the serial ports, the printer port, the USB ports, PS/2 mouse and keyboard ports, Ethernet port, external CF slot, and CD-ROM (CD-R/W) drive are located on the left side of the unit in all models in the PS/PX Series PowerStation. At the back of the unit are the floppy drive connector, an additional serial port, the video connector, and power connector. Be sure to design your enclosure with these locations in mind.

---

**Important** If you have a CD-ROM (CD-R/W) drive, be sure to allow at least 3.5" between the enclosure and the left side of the unit so that the drive tray can open.

---

Refer to your PS/PX/PC Documentation, Drivers, and Utilities CD for dimensional drawings that list location measurements of your system's drives, ports, and controls. Use these dimensions to

customize the mounting of your unit.

## Mounting the System

Mounting procedures for the PowerStation with Function Keypad (PX50, PX51) is different from the mounting procedures for the rest of the PS/PX/PC series. The mounting procedures for the RS/RX/RC series are also different. Follow the procedure for your system, described below.

### Mounting the PowerStation with Function Keypad

The PowerStation with Function Keypad (PX50, PX51) comes with a template designed to simplify the task of creating the cutout. Be sure to follow the drill hole and cutout dimensions precisely so that the PowerStation will seal properly in its enclosure.

To create a cutout for the PowerStation, complete the following steps:

1. Attach the template securely to the mounting surface.
2. Cut out the shaded area of the template referred to as the “Panel Cutout Area.” To maintain the flatness of the mounting surface, CTC Parker recommends that you cut out the Panel Cutout Area rather than punch it out.
3. Drill the appropriate number of 0.23-inch diameter mounting holes as seen on the template. Once again, be careful to protect the flatness of the surface.
4. Debur the edges of the cutout area and the drill holes.
5. Ensure that the mounting surface has remained flat and that the panel surface is clean and free of foreign materials.
6. Refer to your PS/PX/PC Documentation, Drivers, and Utilities CD for dimensional drawings that indicate the depth and port dimensions of your PowerStation. Use these dimensions to customize the mounting of your unit.

Once you have prepared the location for the PowerStation, you can install the unit. For your convenience, CTC Parker includes all the necessary mounting hardware with the unit.

To mount the unit, complete the following steps:

1. Gently insert the PowerStation into the cutout.
2. Install a nut on each of the protruding studs on the back of the PowerStation’s bezel, and tighten each nut to a torque of 17 inch/pounds.

---

**Important** The unit must fit flush in the enclosure. Tighten the nuts in a crosswise sequence to ensure a good seal and prevent damage to the unit.

---

### Mounting the other PS/PX/PC models

To mount the other PS/PX/PC models, complete the following steps:

---

**Note** Necessary mounting clamps and screws are shipped with your system.

---

1. Cut a space in which to mount the unit.

The cutout dimensions will depend upon the size of your system's display and are shown in the following table and can be found on PS/PX/PC Documentation, Drivers, and Utilities CD.

Monitor Size	Cutout Height	Cutout Width
10.4"	9.86" (250.44mm)	12.60"(320.04mm)
12.1"	11.25" (285.75mm)	14.15" (359.41mm)
15.1"	12.40" (314.96mm)	15.90" (403.86mm)
18.1"	14.26" (362.21mm)	17.06" (433.32mm)

2. Debur the cutout area.
3. Make sure that both sides of the panel mounting surface are clean and flat.
4. Slide the unit into the cutout from the front.
5. Attach the mounting clamps to the back of the unit, as shown in the following illustration.

---

**Note** The following image is an illustration of a PXXX-2 model. However, the mounting clips are located in the same place on all models.

---

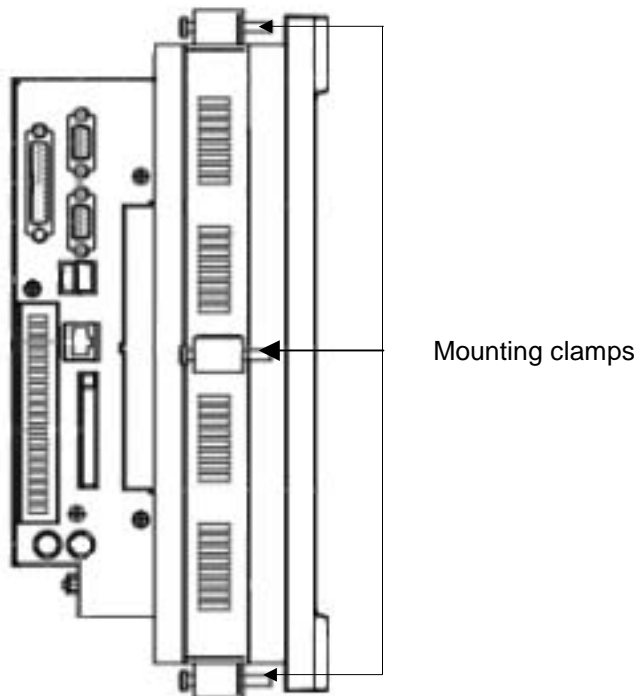

- If you have a system with a 9.5” or 10.4” display, attach 6 mounting clamps, with their screws, to the back of the unit in the spaces provided. You will place 2 clamps at the top and bottom of the unit and 1 on each side, as shown above.
- If you have a system with a 12.1” or 15.1” display, attach 8 mounting clamps, with their screws, to the back of the unit in the spaces provided. You will place 2 clamps at the top and bottom of the unit and 2 on each side.
- If you have a system with a 18.1” display, attach 12 mounting clamps, with their screws, to the back of the unit in the spaces provided. You will place 3 clamps at the top and bottom of the unit and 3 on each side. You must slide the feet of the mounting clip into the slot, then slide the clip over to properly mount the unit.

---

**Note** There are two styles of clamps used to secure the unit to your enclosure. Both styles are illustrated in the figure below. The clamp shown at the top of the figure is used on units with an 18” display while all other units use the clamp shown at the bottom of the figure. The prongs at the bottom of each clamp should hook into the slots in each space. The end of each screw should point toward the front of the enclosure.

---

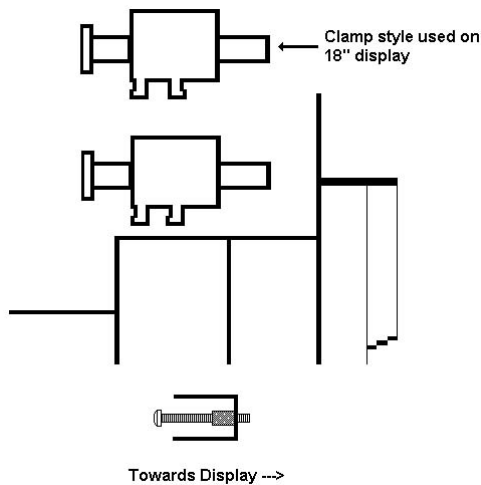

6. Tighten each screw against the front of the enclosure to a torque of 8 lb./in.

## Mounting the RS/RX/RC models

To mount the system, complete the following steps:

---

**Note** Mounting screws are shipped with your system.

---

1. Drill four mounting holes in the panel where you will mount the system.

Measurements for the mounting holes are shown on your PS/PX/PC Documentation, Drivers, and Utilities CD.

2. Make sure that the panel mounting surface is clean and flat.

3. Screw the mounting screws into the holes that you drilled, but do not tighten the screws all the way down.

4. Mount the system by placing the large openings in the mounting slots in the front cover over the screws in the mounting panel, as shown in the illustration below. Slide the unit downward so that the narrow ends of the mounting slots fit underneath the screw-heads.

The unit should fit snugly on the mounting screws. If the unit fits too loosely, remove it, tighten the mounting screws, and remount the unit.

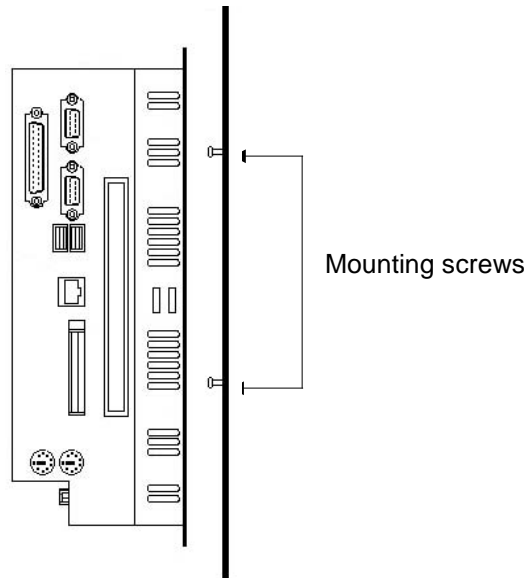

## Connecting the RS/RX/RC Unit to a Monitor

Once you have installed the RS/RX/RC unit, you are ready to connect it to a monitor. This section explains how to connect the system either to CTC's PowerStation RS Monitor or to another monitor.

### Connecting to a PowerStation RS Monitor

To connect the RS/RX/RC to the PowerStation RS Monitor, connect the following cables:

---

**Note** A 15-pin video cable is shipped with the RS Monitor.

---

1. Connect a 15-pin video cable between the monitor's Analog Video Input port and the video port at the back of the computer.

---

**Note** A 9-pin touchscreen cable is shipped with the RS Monitor.

---

2. If you have a touchscreen monitor, follow the steps in *BIOS Setup* on page 50.

3. Connect a 9-pin touch-screen cable to the 9-pin serial port on the RS Monitor and COM3 at the back of the computer.

### Connecting to other monitors

To connect the RS/RX/RC to a non-PowerStation RS Monitor, connect a 15-pin video cable between the video port at the back of the computer and the monitor's video port.

## Starting the System

Once your system has been mounted, you are ready to start it up. This procedure is described in the following paragraphs.

Before connecting power to the unit, make sure that you have read and understood the *Electrical Specifications* on page 109 and *Testing Specifications* on page 109. Also, make sure that you follow the guidelines listed below:

- For permanently connected equipment, a readily accessible disconnect device must be incorporated into the fixed wiring.
- For pluggable equipment, the socket-outlet must be installed near the equipment and should be easily accessible.



### Important

Proper installation of the system in European Union countries requires the use of a harmonized power cord (the power cord must be identified with the <HAR> symbol). Make sure that the system is connected to the main supply with a harmonized power cord.

---

1. Connect the power cord to a voltage source.

Voltage input to the system should be within the range specified in *Electrical Specifications* on page 109.

2. Connect the power cord to the system.
3. Turn the system on.

The following are guidelines for starting under Windows 98, 2000, XP Pro, NT, or Embedded NT; under a multiboot system; or under MS-DOS.

## Starting in Windows 98, 2000, or XP Pro

If you are running Windows 98, 2000, XP Pro Windows will automatically load at startup.

## Starting in Windows NT or Embedded NT

To load Windows NT, or Embedded NT at startup, complete the following steps:

---

**Important** You must have a keyboard connected to the system in order to load Windows NT or Embedded NT.

---

1. Start the system, and press **Ctrl+Alt+Delete**.
2. When the Logon Information window prompts you for the Administrator's password, press **ENTER**, or click **OK** (the password is blank by default).
3. Click **Close** in the Help window if you do not want Help when you first enter Windows NT or Embedded NT.

## Starting in Multiboot Systems

When starting in a multiboot system, you will be shown a menu, in which you will have the option of booting into Windows NT or MS-DOS.

- The PowerStation PS models are set to default to Windows NT.

- You may change the default so that when the system starts, it defaults to MS-DOS.

You may wish to do this so that operators do not have to change the default selection every time the system starts.

To set MS-DOS as the default operating system, complete the following steps:

1. On the Windows taskbar, click **Start ► Settings ► Control Panel**.
2. The Control Panel window will open.
3. In the Control Panel window, click **System**.
4. The System Properties dialog box will open.
5. In the System Properties dialog box, click the **Startup/Shutdown** tab.
6. Select **MS-DOS** from the Startup drop-down list.
7. From the **Show List For** spin box, select the number of seconds the menu is displayed upon startup.
8. Click **OK**.

The next time the system starts, the operating system will default to MS-DOS.

## Starting in MS-DOS

If you are running a PowerStation PS model under MS-DOS, the MachineShop Shell will automatically be loaded at startup.

You are now ready to begin using your system.

- If you are using Interact or MachineLogic software, refer to the *Interact Getting Started Guide* or the *MachineLogic Getting Started Guide* for help in developing your projects.
- Refer to the *MachineShop Getting Started Guide* for information about how to download projects.





# CHAPTER 4: MAINTENANCE

Occasionally, you may need to perform routine maintenance on some system components. This chapter provides instructions for maintenance, as well as steps for solving problems that may occur in operation.

## **Chapter Contents**

---

<i>BIOS Setup</i>	50
<i>Reinstalling Software</i>	57
<i>Restoring a Compact FlashCard</i>	71
<i>Maintaining the Display on a PS/PX/PC</i>	72
<i>Performing Internal Maintenance</i>	76

## BIOS Setup

This section describes various BIOS settings you may modify if necessary. The BIOS version residing on the 266MHz CPU card is slightly different than the BIOS version residing on the 566MHz and 1GHz CPU cards. Screen captures of both utilities are shown below. Read the following steps carefully to ensure you are following the steps applicable to your specific BIOS.

If you want to reset any of the BIOS settings, shut down the system, connect a Keyboard to your PowerStation, and press the **F2** key while the system is starting up to display the BIOS setup window shown below.

### 266MHz CPU Card BIOS Setup Utility

PhoenixBIOS Setup Utility				
Main	Advanced	Security	Power	Exit
System Time				[16:19:20]
System Date:				[03/02/1994]
Legacy Diskette A:				[1.44/1.25 MB 3½"]
Legacy Diskette B				[Not Installed]
▶	Primary Master			6449 MB
▶	Primary Slave			None
▶	Secondary Master			CD-ROM
▶	Secondary Slave			None
Memory Cache				[Enabled]
▶	Keyboard Features			
System Memory				640 kB
Extended Memory				31744 kB
<b>Scroll down to see the following two options</b>				
Boot-time Diagnostic Screen				[Disabled]
▶	Boot Options			
F1 Help	↓ Select Item	-/+ Change Values		F9 Setup Defaults
ESC Exit	↔ Select Menu	Enter Select	▶ Sub-Menu	F10 Save and Exit

## 566MHz/1GHz CPU Card BIOS Setup Utility

PhoenixBIOS Setup Utility		Exit
Main	Advanced	Security
System Time	[16:19:20]	Item Specific Help  <Tab>, <Shift-Tab>, or <Enter> selects field
System Date:	[ 12/19/2002 ]	
Legacy Diskette A:	[1.44/1.25 MB 3½"]	
Legacy Diskette B	[ Disabled ]	
▶ Primary Master	6449 MB	
▶ Primary Slave	None	
▶ Secondary Master	CD-ROM	
▶ Secondary Slave	None	
Memory Cache	[Enabled]	
▶ Keyboard Features		
System Memory	640 kB	
Extended Memory	31744 kB	
BIOS Date	12/12/02	
Splash Screen	[ Enabled ]	
F1 Help	↑↓Select Item	
ESC Exit	↔Select Menu	Enter Select ▶Sub-Menu
		F9 Setup Defaults
		F10 Save and Exit

You can use the BIOS utility to perform the following functions on your PowerStation:

- Configure the touchscreen and serial ports
- Reset the disk boot priority (CompactFlash, Hard Drive, or Floppy)
- Adjust the display brightness
- Load the default BIOS settings
- Remove the CTC splash screen

## Configuring the Touchscreen and Serial Ports

To configure the serial ports, complete the following steps:

1. Start the system, and while the system is starting up, press the **F2** key on your keyboard.
2. The PhoenixBIOS Setup Utility screen will appear.
3. Select the **Advanced** tab to display the following BIOS screen.

## 266MHz CPU Card BIOS Setup Utility

PhoenixBIOS Setup Utility				
Main	Advanced	Security	Power	Exit
Warning!				Item Specific Help
Setting items on this menu to incorrect values may cause your system to malfunction.				Select the operating system installed on you system that you use most often.  Note: An incorrect setting can cause unexpected behavior in some operating systems.
CPU Type		Pentium with MMX		
CPU Speed		266 MHz		
Cache RAM		512 KB		
▶ LCD Configuration				
Installed Operating System		[Other]		
Reset Configuration Data:		[No]		
PS/2 Mouse		[Enabled]		
DRAM Speed:		[60ns]		
Large Disk Access Mode:		[DOS]		
Local Bus IDE adapter:		[Both]		
SMART Device Monitoring:		[Enabled]		
<b>Scroll down to see the following two options</b>				
▶ PCI Configuration				
▶ I/O Device Configuration				
F1 Help	↓ Select Item	-/+ Change Values	F9 Setup Defaults	
ESC Exit	↔ Select Menu	Enter Select	▶ Sub-Menu	F10 Save and Exit

## 566MHz/1GHz CPU Card BIOS Setup Utility

PhoenixBIOS Setup Utility					
Main	Advanced	Security	Boot	Power	Exit
					Item Specific Help
CPU Type		Pentium (R) III			
CPU Speed		1000 MHz			
Cache RAM		256 KB			
▶ LCD Configurati...					
Installed OS		[Other]			
Reset Configuration Data:		[No]			
PS/2 Mouse		[Auto Detect]			
Large Disk Access Mode:		[DOS]			
Local Bus IDE adapter:		[Both]			
SMART Device Monitoring:		[Enabled]			
▶ PCI Configuration					
▶ I/O Device Configuration					
▶ Advanced Chipset Control					
Legacy USB Support:		[Disabled]			
F1 Help	↑↓ Select Item	-/+ Change Values	F9 Setup Defaults		
ESC Exit	↔ Select Menu	Enter Select	▶ Sub-Menu	F10 Save and Exit	

4. Scroll down to **I/O Device Configuration**.

5. Press **ENTER**.

A list of Serial Ports is displayed, as shown on the following page.

## 266MHz CPU Card BIOS Setup Utility

PhoenixBIOS Setup Utility		
Advanced		
I/O Device Configuration		Item Specific Help
Serial Port A:	[Enabled]	Set Serial Port A: Using options:
Base I/O address	[3F8]	
Interrupt	IRQ4	
Serial Port B:	[Enabled]	Disabled [No configuration]
Base I/O address	[2F8]	
Interrupt	IRQ3	
Serial Port C:	[Enabled]	Enabled [User configuration]
Base I/O address	[2E8]	
Interrupt	IRQ 9	
Touchscreen:	[Enabled]	Auto [BIOS configuration]
Base I/O address	[3E8]	
Interrupt	IRQ 11	
Parallel Port:	[Auto]	OS Controlled [OS configuration]
Mode:	[Bi-directional]	
Floppy disk controller:	[Auto]	
F1 Help    ↑Select Item    -/+ Change Values    F9 Setup Defaults ESC Exit    ↔Select Menu    Enter Select    ▶Sub-Menu    F10 Save and Exit		

## 566MHz/1GHz CPU Card BIOS Setup Utility

PhoenixBIOS Setup Utility		
Advanced		
I/O Device Configuration		Item Specific Help
Serial port A:	[Enabled]	Configure serial Port A: using options:
Base I/O address	[3F8]	
Interrupt	[IRQ4]	
Serial port B:	[Enabled]	[Disabled] No configuration
Base I/O address	[2F8]	
Interrupt	[IRQ 3]	
Serial port C:	[Enabled]	[Enabled] User configuration
Base I/O address	[2E8]	
Interrupt	[IRQ 9]	
Touchscreen:	[Enabled]	[Auto] BIOS or OS chooses configuration
Base I/O address	[3E8]	
Interrupt	[IRQ 11]	
Parallel port A:	[Auto]	[OS Controlled] Displayed when controlled by OS
Mode:	[Bi-directional]	
Floppy disk controller:	[Auto]	
F1 Help    ↑↓Select Item    -/+ Change Values    F9 Setup Defaults ESC Exit    ↔Select Menu    Enter Select    ▶Sub-Menu    F10 Save and Exit		

These are the default settings. Note that the touchscreen is assigned to COM3 (3E8), and that Serial Port C, located at the back of the unit, is assigned to COM4 (2E8).

**Note** The default setting for the touchscreen is enabled. The RS/RX/RC touchscreen setting is manually set to disabled at the factory before it is shipped.

6. To configure all serial ports to the factory defaults, select F9.

## Resetting Disk Boot Priority

To reset the disk boot priority, complete the following steps:

1. Start the system, and while the system is starting up, press the **F2** key on your keyboard.
2. The PhoenixBIOS Setup Utility screen will appear.
3. Select the **Boot** tab if it is not displayed.

The following list is an example of the boot order list.

### 266MHz CPU Card BIOS Setup Utility

PhoenixBIOS Setup Utility	
Main	
Boot Options	Item Specific Help
-Hard Drive SanDisk SDCFB16-(SS) -Removable Devices Legacy Floppy Drives ATAPI CD-ROM Drive Network Boot	<+> or <-> moves device up or down. <Enter> expands or collapses devices marked with + or -. <Ctrl+Enter> expands all <Shift+l> enables or disables a device. <n> moves a removable device between hard or removable disk.
F1 Help      ↓ Select Item      -/+ Change Values ESC Exit     ↔ Select Menu      Enter Select      ▶ Sub-Menu	F9 Setup Defaults F10 Save and Exit

## 566MHz/1GHz CPU Card BIOS Setup Utility

PhoenixBIOS Setup Utility			
Main	Advanced	Security	Boot Power Exit
Boot Options		Item Specific Help	
+ Removable Devices + Hard Drive ATAPI CD-ROM Drive Network Boot		Keys used to view or configure devices: <Enter> expands or collapses devices with a + or - <Ctrl + Enter> expands all <Shift + I> enables or disables a device. <+> and <-> moves the device up or down. <n> May move removable device between Hard Disk or Removable Disk <d> Remove a device that is not installed.	
F1 Help	↑↓Select Item	-/+ Change Values	F9 Setup Defaults
ESC Exit	↔Select Menu	Enter Select	▶ Sub-Menu F10 Save and Exit

The system will try to boot from the first item on the list. If the system cannot boot from the first item, it tries to boot from the second item, and so forth down the list until it can boot. In the example above, the PS PowerStation will try to boot from the SanDisk, then the Hard Drive, then the CD-ROM (or CD-R/W if installed), and finally the network.

---

**Note** The list may include IDE hardware that is not currently installed on the system, but was installed at one time. This feature is called the “**Sticky IDE**” feature. If your boot order list includes “**!Secondary Master**” or “**!Secondary Slave**,” it is a function of the “Sticky IDE” feature. Using this feature, the BIOS can recognize when a CompactFlash is in the unit. This enables the unit to boot from the CompactFlash when the CompactFlash is in the unit, and from the Hard Drive when the CompactFlash has been removed.

---

4. Decide in which order you want the boot list. Press the + or – sign on the keyboard to move the selected device up or down in the boot order priority list.

---

**Note** The devices which have a + sign next to them contain sub-items. The **ENTER** key expands or collapses the sub-list.

---

## Loading Default BIOS Settings

To reload the default BIOS settings, complete the following steps:

1. Start the system, and while the system is starting up, press the **F2** key on your keyboard.
2. The PhoenixBIOS Setup Utility screen will appear.
3. In the **Exit** menu, select the **Load Setup Defaults** option.
4. In the Advanced menu, change the **Reset Configuration Data** to **Yes**.
5. When the system restarts, this setting will automatically switch back to **No**.
6. Save these settings, and exit the setup program.
7. Restart the system.

When the system restarts, the default BIOS settings will be re-established.

## Removing the CTC Splash Screen

1. Start the system, and while the system is starting up, press the **F2** key on your keyboard.

The PhoenixBIOS Setup Utility screen will appear.

2. From the **Main** tab of the BIOS, scroll down to **Boot-time Diagnostic Screen** or **Splash Screen** (566MHz/1GHz boards) as shown below.

### 266MHz CPU Card BIOS Setup Utility

PhoenixBIOS Setup Utility		Exit
Main	Advanced	Security
System Time	[16:19:20]	Item Specific Help
System Date:	[03/02/1994]	<Tab>, <Shift-Tab>, or <Enter> selects field
Legacy Diskette A:	[1.44/1.25 MB 3½"]	
Legacy Diskette B	[Not Installed]	
▶ Primary Master	6449 MB	
▶ Primary Slave	None	
▶ Secondary Master	CD-ROM	
▶ Secondary Slave	None	
Memory Cache	[Enabled]	
▶ Keyboard Features		
System Memory	640 kB	
Extended Memory	31744 kB	
<b>Scroll down to see the following two options</b>		
Boot-time Diagnostic Screen	[Disabled]	
▶ Boot Options		
F1 Help	↓ Select Item	-/+ Change Values
ESC Exit	↔ Select Menu	Enter Select ▶ Sub-Menu
		F9 Setup Defaults
		F10 Save and Exit



### 566MHz/1GHz CPU Card BIOS Setup Utility

PhoenixBIOS Setup Utility			
Main	Advanced	Security	Boot Power Exit
System Time			[16:19:20]
System Date:			[ 12/19/2002 ]
Legacy Diskette A:			[1.44/1.25 MB 3½"]
Legacy Diskette B			[ Disabled ]
▶	Primary Master		6449 MB
▶	Primary Slave		None
▶	Secondary Master		CD-ROM
▶	Secondary Slave		None
Memory Cache			[Enabled]
▶	Keyboard Features		
System Memory			640 kB
Extended Memory			31744 kB
BIOS Date			12/12/02
Splash Screen			[ Enabled ]
Item Specific Help			
<Tab>, <Shift-Tab>, or <Enter> selects field			
F1 Help	↑↓Select Item	-/+ Change Values	F9 Setup Defaults
ESC Exit	↔Select Menu	Enter Select ▶Sub-Menu	F10 Save and Exit

3. Press the + key to toggle the **Boot-time Diagnostic Screen** setting to **[Enabled]** or toggle the **Splash Screen** setting to **[Enabled]**.

## Reinstalling Software

The PS/PX/RS/RX models come pre-loaded with the operating system and all of the other software that you purchased. This software may be installed on your system's hard drive if you have purchased one, or on the system's internal or external Compact Flash cards. (See *Drive Functions* on page 25 for information about how a hard drive and CF cards work in your system.)

Backup copies of your software are provided on the CDs and floppy disks shipped with your system. If any of the software on your system becomes lost or corrupted, you can reinstall it from these distribution disks.

This discussion of reinstalling software is organized into several parts:

- *Reinstalling Software on Systems Running Windows*
  - *Repairing Windows from the Emergency Recovery Disk*
  - *Reinstalling the video driver*
  - *Reinstalling the touchscreen driver*
  - *Reinstalling the network driver*
  - *Reinstalling PowerSmart*
  - *Reinstalling MachineShop*
  - *Reinstalling InteractX Utilities*

- *Reinstalling Software on Systems Running MS-DOS*
  - *Reinstalling drivers and PowerStation Utilities*
  - *Reinstalling the touchscreen driver*
  - *Reinstalling the MachineShop Shell*

## Reinstalling Software on Systems Running Windows

This section explains how to reinstall necessary software on systems running Windows 98, NT 4.0, Embedded NT 4.0, 2000, or XP Pro. If you do not have a system that runs Windows, you may skip this section.

---

**Important** To reinstall the software described in this section, you must have a CD-ROM (or CD-R/W) drive installed on your system.

---

To reinstall software on systems running Windows, you will need the following CDs/disks:

- Windows 98, NT 4.0, Embedded NT 4.0, 2000, or XP Pro OEM Packet
- PS/PX/PC Documentation, Drivers, and Utilities CD

---

**Note** If you need additional help reinstalling any of the software described in this section, consult the PS/PX/PC Documentation, Drivers, and Utilities CD, check the Support page on the CTC website [www.ctcusa.com](http://www.ctcusa.com), or call our Technical Support department at 513-248-1714.

---

## Repairing Windows from the Emergency Recovery Disk

If the operating system becomes damaged, you have the option of repairing the system in one of two ways: you can perform a clean install from the CD and reinstall all of your software, or you can repair the system using the Emergency Recovery Disk.

Repairing the operating system from the Emergency Recovery Disk allows you to reinstall basic operating system components that are damaged while leaving the registry intact. This means you will not have to reinstall the software or adjust the settings on your unit. The Emergency Recovery Disk also allows you to customize the installation and specify which components you need reinstalled such as a CD ROM driver.

To repair windows, you will need the following:

To Install . . .	You will need . . .
Windows 98	Windows 98 OEM Packet Windows 98 Boot Disk (included with the OEM Packet)
Windows 2000	Windows 2000 OEM Packet
Windows NT 4.0	Win NT 4.0 Emergency Recovery Disk
Windows Embedded NT 4.0	Win Embedded NT 4.0 Emergency Recovery Disk
Windows XP Pro	Windows XP OEM Packet

1. Insert the CD for your operating system into the CD-ROM drive.
2. Boot your computer from the CD-ROM drive.

3. Follow the directions to either repair or reinstall your operating system.

You should first attempt to repair your operating system first. If you still do not have the functionality desired then perform the steps above except reinstall the operating system from scratch.

After reinstalling the operating system, you have to reinstall the video, touchscreen, network, and PowerSmart drivers.

## Reinstalling the video driver

---

**Note**     **Applicable to 266MHz CPU boards:** Under Windows 2000 and XP Pro the video driver is incorporated into the operating system. So if you've installed the operating system, you've already installed the video driver.

---

These procedures are slightly different based on the type of CPU board installed in your unit. Follow the procedure for your specific board.

### Reinstall the Video Driver for Windows 98 (266MHz CPU Board)

To reinstall the video driver under Windows 98, complete the following steps:

1. Start the system, and insert the PS/PX/PC Documentation, Drivers, and Utilities CD into the system's CD-ROM drive.
2. Select the **Hardware Drivers and Utilities** button.
3. Select the **Windows Video Drivers** button.
4. Select the **266MHz Processor** button and choose your driver from this screen.
5. Follow the wizard instructions and your driver will be installed.

When installation is complete, restart the system.

---

**Note**     You must restart the system for your installation to take effect.

---

### Reinstall the Video Driver for Windows NT/Embedded NT (266MHz CPU Board)

To reinstall the video driver under Windows NT 4.0, complete the following steps:

1. On the Windows taskbar, click **Start ► Settings ► Control Panel**.
2. Click **Display**.
3. Click the **Settings** tab.
4. Click **Display Type**.
5. Click **Change in Adapter Type**.
6. Insert the PS/PX/PC Documentation, Drivers, and Utilities CD into the system's CD-ROM drive.
7. Click **Have Disk**.
8. Under "Copy manufacturer's files from," type **D:\Drivers\Video\266MHz Max. Processor\WINNT40**.
9. Select the **oemsetup.inf** file then click **OK**.

---

**Note**     In this example, **D** represents the letter of your CD-ROM drive. If your system has assigned a different letter to the CD-ROM drive, type the appropriate letter.

---

10. Select **Chips Video Accelerator** from the Display list, and then click **OK**.

A warning about third-party drivers will appear.

11. Click **Yes** to complete the installation.

12. When installation is complete, restart the system.

---

**Note** You must restart the system for your installation to take effect.

---

### **Reinstall the Video Driver for Windows 98, 2000, or XP Pro (566MHz – 1GHz CPU Board)**

To reinstall the video driver under Windows 98, 2000, or XP Pro complete the following steps:

1. On the Windows taskbar, click **Start ► Settings ► Control Panel**.
2. Click **Display**.
3. Click the **Settings** tab.
4. Click the **Advanced** button.
5. Click the **Adaptor** button.
6. Click the **Change** button.
7. Click **Next**.
8. Select “**Display a list of all drivers...**”
9. Insert the PS/PX/PC Drivers and Utilities CD into the system’s CD-ROM drive.
10. Click **Have Disk**.
11. For Windows 98 systems, browse to **D:\Drivers\Video\300MHz 1GHz Processor\WIN98**.
12. For Windows 98 systems, select the **chips98.inf** file then click **OK**.
13. For Windows 2000 and XP Pro systems, browse to **D:\Drivers\Video\300MHz 1GHz Processor\WIN2K (or WINXP)**.
14. For Windows 2000 and XP Pro systems, select the **chips2K.inf (or chipsxp.inf)** file then click **OK**.

---

**Note** In this example, **D** represents the letter of your CD-ROM drive. If your system has assigned a different letter to the CD-ROM drive, type the appropriate letter.

---

15. Select **Chips and Tech. 69030 AGP/PCI** from the Display list, and then click **OK**.

16. When installation is complete, restart the system.

---

**Note** You must restart the system for your installation to take effect.

---

### **Reinstall the Video Driver for Windows NT/Embedded NT (566MHz – 1GHz CPU Board)**

To reinstall the video driver under Windows NT 4.0, complete the following steps:

1. On the Windows taskbar, click **Start ► Settings ► Control Panel**.
2. Click **Display**.

3. Click the **Settings** tab.
4. Click **Display Type**.
5. Click **Change in Adapter Type**.
6. Insert the PS/PX/PC Drivers and Utilities CD into the system's CD-ROM drive.
7. Click **Have Disk**.
8. Under “**Copy manufacturer's files from,**” type **D:\Drivers\Video\300MHz 1GHz Processor\WINNT40**.
9. Select the **oemsetup.inf** file then click **OK**.

---

**Note** In this example, **D** represents the letter of your CD-ROM drive. If your system has assigned a different letter to the CD-ROM drive, type the appropriate letter.

---

10. Select **Chips Video Accelerator** from the Display list, and then click **OK**.

A warning about third-party drivers will appear.

11. Click **Yes** to complete the installation.
12. When installation is complete, restart the system.

---

**Note** You must restart the system for your installation to take effect.

---

## Reinstalling the touchscreen driver

The touchscreen driver in the PS/PX/PC Series PowerStation is the Touchbase Universal Pointing Device Driver (UPDD). Use the following instructions to install the driver under Windows 98, 2000, NT 4.0, Embedded NT 4.0, or XP Pro. If you have an RS/RX system, you may skip this section.

### Reinstalling the touchscreen driver under Windows 98, NT, or Embedded NT

To reinstall the touchscreen driver under Windows 98, NT, or Embedded NT you will make note of the touchscreen IRQ and address values, you will install the driver, and then you will verify the settings.

#### Identifying the IRQ and address values

---

**Note** If you have not changed the IRQ and address settings from the default, skip to the next section, *Installing the driver*.

---

1. Start the system, and while the system is starting up, press the **F2** key on your keyboard.
2. The PhoenixBIOS Setup Utility screen will appear.
3. Select the **Advanced** tab.
4. Scroll down to **I/O Device Configuration**.
5. Press **ENTER**.

A list of Serial Ports is displayed. See the following table.

Serial Ports	Address	IRQ
A	3F8	4
B	2F8	3

C	2E8	9
Touchscreen	3E8	11

6. Make a note of the touchscreen address and IRQ settings. You will need these to verify the settings after you install the driver.

---

**Note** The default setting for the I/O Port is **3E8** and the IRQ is **11**.

---

### Installing the driver

To install the touchscreen driver under Windows 98, NT, or Embedded NT, complete the following steps:

1. Insert the PS/PX/PC PowerStation Documentation, Utilities, and Drivers CD into your CD-ROM drive.
2. Select the **Hardware Drivers and Utilities** button from the main menu.
3. Follow the instructions to select the correct touchscreen driver for this operating system.
4. Follow the installation wizard to install the driver.
5. After installation is complete, restart the computer.

---

**Note** You must restart the computer for your installation to take effect.

---

### Verifying the settings

---

**Important** To verify the touchscreen settings, you must know the touchscreen IRQ and address settings. If you are not sure what these settings are, complete steps 1-6 under *Identifying the IRQ and address values* on page 61.

---

To verify that the system recognizes the correct IRQ and I/O Port Address settings, complete the following:

1. Select **Start-Programs-UPDD-Settings**.

The Pointer Device Properties window will appear.

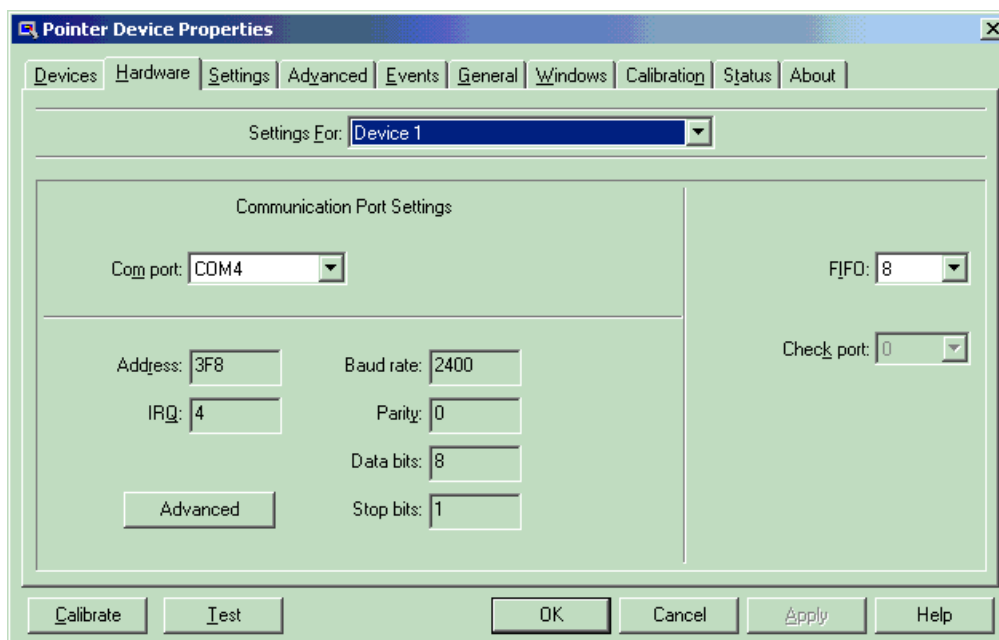

2. Select the **Hardware** tab.
3. Compare the Address and IRQ settings with the jumper settings that you noted in step 5 of the section *Identifying the IRQ and address values* on page 61.
4. Complete one of the following:

Settings	Action
If the settings match	Continue with step 5.
If the settings <b>do not</b> match	<ol style="list-style-type: none"> <li>1. Press the Advanced button.</li> <li>2. Change the Address and IRQ settings to match the settings of the previous section.</li> <li>3. Press Apply.</li> <li>4. Press OK.</li> </ol>

5. Calibrate the touchscreen if necessary. For instructions, see *Recalibrating the Touchscreen* on page 74.

### Reinstalling the touchscreen driver under Windows 2000 or XP Pro

To install the touchscreen driver under Windows 2000 or XP Pro, you will identify the driver COM port or install a new COM port (first time installation), install the driver, and then configure the driver settings.

#### Identifying the driver COM port

How you identify the driver COM port will depend upon whether you are replacing an existing installation of the driver (e.g., a corrupted driver) or installing the driver on a computer for the first time (e.g., under a new operating system).

If you are reinstalling the driver to replace an existing installation, you must determine the present driver COM port, using the Windows Device Manager.

If you are installing the driver for the first time, you must install a new driver COM port, using the Add New Hardware Wizard.

To identify the present touchscreen driver COM port, complete the following steps:

1. On the Windows taskbar, select **Start ► Settings**.
2. On the Settings submenu, select **Control Panel**.
3. In Control Panel, select the **System** icon.
4. In the System Properties dialog box, select the **Hardware** tab.
5. On the Hardware tab, select the **Device Manager** button.
6. On the Device Manager menu, open the **Ports** directory.
7. Double-click on a port.

---

**Note** The most likely choice is the third port in the list.

---

The port's Properties sheet will appear.

8. Select the **Resources** tab, and look in the **Resource settings** group box to determine if the port uses **3E8** and **IRQ 11**.

This will be the touchscreen driver COM port.

9. Check each port until you find the touchscreen driver COM port; then make a note of this port to use when you install the touchscreen driver.

### Reinstalling the touchscreen driver

To install the touchscreen driver, complete the following steps:

---

**Important** To install the touchscreen driver, you must know the driver COM port number. If you are not sure what this number is, complete steps 1-9 under *Identifying the COM port* on page 63.

---

1. Insert the PS/PX/PC PowerStation Documentation, Utilities, and Drivers CD into your CD-ROM drive.
2. Select the **Hardware Drivers and Utilities** button from the main menu.
3. Follow the instructions to select the correct touchscreen driver for this operating system.
4. Follow the installation wizard to install the driver.
5. After installation is complete, restart the computer.
6. Run the Universal Pointing Device Driver.
7. Choose the COM port that matches the hardware settings from the table below.

Address	COM Port
3F8	1
2F8	2
3E8	3
2E8	4

8. Press **Finish** after the installation is complete.
9. Restart the computer.
10. Calibrate the touchscreen if necessary. For instructions, see *Recalibrating the Touchscreen* on page 74.

---

**Note** Once the touchscreen driver is installed, you can create a UPDD “clone” file that you can copy to your Touch directory and use if you need to reinstall the driver under Windows 2000 or XP Pro. The clone file greatly simplifies the installation procedure. See the UPDD online Help for instructions on how to create and use this clone file. If your touchscreen is on the default address 3E8, IRQ 11, then a clone file already exists for these settings on the Documentation, Drivers, and Utility CD.

---

### Reinstalling the network driver

---

**Note** **Applicable to 266MHz CPU boards:** Under Windows 2000 and XP Pro, the network driver loads automatically when Windows is installed.

---

These procedures are slightly different based on the type of CPU board installed in your unit. Follow the procedure for your specific board.

#### Reinstall network driver under Windows 98 (266MHz CPU Board)

To reinstall the network driver under Windows 98, complete the following steps:

1. On the Windows taskbar, click **Start ► Settings ► Control Panel**.



The Control Panel will appear.

2. Click **System**.
3. Click the **Device Manager** tab.
4. Click the + sign next to Network adapters.

A list of installed network drivers will appear.

5. Select the **Intel 8255X-Based PCI Ethernet Adapter (10/100)**.

---

**Note** This driver should have an exclamation point (!) next to it.

---

6. Click **Remove**, and follow the prompts on screen to uninstall the driver.

7. Restart the system.

The New Hardware Found dialog box will appear. It will identify the network adapter as a **PCI Ethernet Controller**.

8. Click **Cancel** and let Windows continue to boot.
9. Insert the PS/PX/PC PowerStation Documentation, Utilities, and Drivers CD into your CD-ROM drive.
10. Select the **Hardware Drivers and Utilities** button from the main menu.
11. Follow the instructions to select the correct network driver for this operating system.
12. Follow the installation wizard to install the driver.
13. In the Update Device Driver Wizard, click **Next**.

The wizard will list the driver it has found as **Intel (R) PRO/100+ PCI Adapter**.

14. Click **Finish**.
15. When installation is complete, restart the system.

---

**Note** You must restart the system for your installation to take effect.

---

### Reinstall the network driver under Windows NT or Embedded NT (266MHz CPU Board)

To reinstall the network driver under Windows NT 4.0 or Embedded NT 4.0, complete the following steps:

1. On the Windows taskbar, click **Start ► Settings ► Control Panel**.
2. Click **Network**.
3. Click the **Adapter** tab.
4. On the Adapter tab, click **Add**.

The Select Network Adapters dialog box will appear with a list of installed network drivers.

5. Do not select a driver from this list. Instead, insert the PS/PX/PC PowerStation Documentation, Drivers, and Utilities CD into the system's CD-ROM drive.



#### **Important**

You must load the Ethernet driver provided by CTC Parker. Using any of the drivers provided by Windows will cause a General Protection Fault; all programs will fail to respond.

---

6. Select the **Explore CD** button from the main menu.
7. Under the following directory, read the **README CTC.TXT** file for instructions to select the correct network driver for this operating system:

\\Drivers\Pro 100 Ethernet

8. Follow the installation wizard to install the driver.
9. Return to the Select Network Adapters dialog within Windows and click **Have Disk**.

The Install from Disk dialog box will appear.

10. Select the appropriate driver for your system configuration as indicated in the **README CTC.TXT** file that you reviewed in step 7.
11. Follow the prompts to complete the installation.
12. When installation is complete, restart the system.

---

**Note** You must restart the system for your installation to take effect.

---

### **Reinstall the network driver under Windows 98, 2000, or XP Pro (566MHz – 1GHz CPU Board)**

To reinstall the video driver under Windows 98, 2000, or XP Pro complete the following steps:

1. Start the system, and insert the PS/PX/PC Documentation, Drivers, and Utilities CD into the system's CD-ROM drive.
2. Select the **Pro 100 Ethernet Install Guide** button.
3. Click the **Choosing the Correct Driver** button.
4. Follow the instructions listed in the text file and your driver will be installed.
5. When installation is complete, restart the system.

---

**Note** You must restart the system for your installation to take effect.

---

### **Reinstall the network driver under Windows NT or Embedded NT (566MHz – 1GHz CPU Board)**

To reinstall the network driver under Windows NT 4.0 or Embedded NT 4.0, complete the following steps:

1. On the Windows taskbar, click **Start ► Settings ► Control Panel**.
2. Click **Network**.
3. Click the **Adapter** tab.
4. On the Adapter tab, click **Add**.

The Select Network Adapters dialog box will appear with a list of installed network drivers.

5. Do not select a driver from this list. Instead, insert the PS/PX/PC PowerStation Documentation, Utilities, and Drivers CD into the system's CD-ROM drive.



**Important**

You must load the Ethernet driver provided by CTC Parker. Using any of the drivers provided by Windows will cause a General Protection Fault; all programs will fail to respond.

---

6. Select the **Explore CD** button from the main menu.
7. Under the following directory, read the **README CTC.TXT** file for instructions to select the correct network driver for this operating system:

\\Drivers\Pro 100 Ethernet

8. Follow the installation wizard to install the driver.
9. Return to the Select Network Adapters dialog within Windows and click **Have Disk**.

The Install from Disk dialog box will appear.

10. Select the appropriate driver for your system configuration as indicated in the **README CTC.TXT** file that you reviewed in step 7.
11. Follow the prompts to complete the installation.
12. When installation is complete, restart the system.

---

**Note** You must restart the system for your installation to take effect.

---

## Reinstalling PowerSmart

Use the following instructions to reinstall the PowerSmart system monitor utility under MS-DOS, Windows 98, 2000, XP Pro NT 4.0, or Embedded NT 4.0.

To reinstall PowerSmart, complete the following steps:

1. Start the system, and insert the PS/PX/PC PowerStation Documentation, Utilities, and Drivers CD into your CD-ROM drive.
2. Select the **Hardware Drivers and Utilities** button from the main menu.
3. Click the **PowerSmart Utility** button.
4. Select the correct utility for this operating system. If installing on an MS-DOS system be sure to select the **README First for DOS** button for important information.
5. When installation is complete, restart the system.

---

**Note** You must restart the system for your installation to take effect.

---

## Reinstalling MachineShop

Use the following instructions to reinstall the MachineShop development suite or any of its components on one of the PowerStation PS models. If you do not have a PowerStation, you can skip this section.

1. Start the system, and insert the PS/PX/PC PowerStation Documentation, Utilities, and Drivers CD into your CD-ROM drive.
2. Select the **Bundled HMI Software Utilities** button from the main menu.
3. Select the **Interact Utilities** button from the sub-menu.
4. Select the **MachineShop Toolbar Installer** button from the sub-menu.

The Setup Welcome dialog box will appear.

5. If you have previously installed MachineShop, a special Setup Welcome dialog box will appear allowing you to modify, repair, or remove the installation. If you select **Modify**, and click **Next**, the

Select Operation dialog box will appear.

6. Click **MachineShop Suite**, and follow the installation wizard to install MachineShop.

---

**Note** You may choose to install Adobe Acrobat as part of your suite installation. If, after Acrobat installs, you are prompted to restart your computer, select **No**, and then click **Finish** to allow your system to complete the MachineShop Suite installation.

---

## Reinstalling InteractX Utilities

Use the following instructions to reinstall Parker MachineShop Suite or InteractX Runtime only software.

1. Start the system, and insert the PS/PX/PC PowerStation Documentation, Utilities, and Drivers CD into your CD-ROM drive.
2. Select the **Bundled HMI Software Utilities** button from the main menu.
3. Select the **InteractX HMI Utilities** button from the sub-menu.
4. Select the button that represents the software you wish to install from the sub-menu.

When installation is complete, restart the system.

## Reinstalling PowerStation Software on Systems Running MS-DOS

This section explains how to reinstall the MachineShop Shell, and essential drivers and PowerStation utilities on your system. The procedures described below must be completed under MS-DOS. If you are running Windows 98 or NT on your system, restart the system in MS-DOS mode.

To reinstall software on systems running MS-DOS, you will need the following CDs/disks:

- MS-DOS 6.22 and Utilities Installation Disk
- PS/PX/PC Documentation, Drivers, and Utilities CD
- MachineShop CD

To reinstall the software described in this section, you must have an external floppy disk drive connected to your PowerStation.

---

**Note** If you need additional help reinstalling any of the software described in this section, consult the PS/PX/PC Documentation, Drivers, and Utilities CD, check the Support page on the CTC website [www.ctcusa.com](http://www.ctcusa.com), or call our Technical Support department at 513-248-1714.

---

## Reinstalling drivers and PowerStation utilities

The PowerStation drivers and utilities are stored on the PS/PX/PC PowerStation Documentation, Drivers, and Utilities CD.

To reinstall all necessary drivers and utilities, such as the touchscreen, video, and network drivers, in the PS Series PowerStation, complete the following steps:

1. Insert the MachineShop CD into a CD-ROM drive.
2. Follow the instructions to create a PowerStation Start disk on a floppy disk.

3. Insert the created PowerStation Start Disk into the system's floppy drive.
4. If necessary, change to the root directory of drive A by typing **A:**
5. Press **Enter** to execute this command.
6. At the DOS prompt, type **Install A: C:**

---

**Note** In this example, C represents the drive letter of the device on which you want to install the PowerStation Utilities—either a hard drive or CF card. If you are using both a hard drive and a CF card in your system, type the appropriate drive letter.

---

7. Press **Enter** to execute this command.
8. Follow the instructions to install the files.

The system will copy the necessary PowerStation files from the Start Disk and unzip them.

At the end of the installation, you will be asked if you would like the factory-default **Autoexec.bat** and **Config.sys** files to be copied to the root directory of drive C.

If you answer **Yes**, the existing Autoexec.bat and Config.sys files will be renamed as Autoexec.old and Config.old.

If you answer **No**, the factory-default files will be copied as Autoexec.ctc and Config.ctc in the CTC directory of drive C.

9. We recommend that you type **Y** for Yes.

10. After the Autoexec.bat and Config.sys files have been copied onto your system, press any key to continue.

The PowerStation utilities installation is complete.

You will be asked if you want to recalibrate the touchscreen.

11. If you have a system with touchscreen, type **Y** for Yes, and recalibrate the touchscreen (see *Recalibrating the Touchscreen* on page 74 for instructions). If you do not have a touchscreen, type **N** for No.

At this point, you will be prompted to install the MachineShop Shell. If you have to do this refer to the steps below for instructions.

---

**Note** You must restart the system for your installation to take effect.

---

**For touchscreen units:** The following files will be placed in the \TOUCH directory on your hard drive.

Directory	File
\TOUCH	TBDriver
	TBDDemo
	TBCal
	TBDiag
	TBMouse

---

**Note** When the touchscreen software is installed, the configuration parameters will be set according to your desired configuration. You should not need to change them.

---

- To change the address or IRQs from the touch directory, type the following line to get the command options:

```
C:\TOUCH>tbdriver /?
```

---

**Note** Include a space between the driver and the backslash.

---

## Reinstalling the MachineShop Shell

To reinstall the MachineShop Shell, complete the following steps:

1. Insert the MachineShop Shell Installation Disk into the system's external floppy disk drive.

---

**Note** The MachineShop Shell Installation Disk is part of the Runtime Workstation Disk Set, which you can create from the MachineShop CD. See the *MachineShop Installation Booklet* for instructions on how to create this disk.

---

2. If necessary, change to the root directory of drive A by typing **A:.**

3. Press **Enter** to execute this command.

4. At the DOS prompt, type **Install A: C:**

---

**Note** In this example, C represents the drive letter of the device on which you want to install the MachineShop Shell—either a hard drive or CF card. If you are using both a hard drive and a CF card in your system, type the appropriate drive letter.

---

5. Press **Enter** to execute this command.

You will be asked if you want to continue with the installation.

6. Type **Y** for Yes in order to continue.

The system will copy the MachineShop Shell files onto the system's hard drive or CF card. It will copy Shell files into the CTC directory.

---

**Note** The touchscreen drivers are copied into the Touch\Dox directory, and network drivers are copied into the Net directory.

---

7. Restart the system.

---

**Note** You must restart the system for your installation to take effect.

---

The system will display the MachineShop Shell.

## Restoring a Compact FlashCard

---

**Note** If you do not have a PowerStation that runs on a CF card, you can skip this section.

---

If you use a Compact Flash (CF) card as the startup drive in a PowerStation, you may need to create a bootable CF card for the system from a blank or used card. This procedure will fix a DOS Shell Compact Flash and allow you to do the following:

- Replace deleted or corrupted files on a CF card
- Prepare a new card for use

You can easily reformat a Compact Flash card by using CTC's FlashBack utility, which restores the MS-DOS operating system and PowerStation operating files to a CF card in one, simple operation. To do this, you will open FlashBack on the PS/PX/PC Documentation, Drivers, and Utilities CD shipped with your system and use the instructions in the FlashBack online help to reformat the CF card.



### Important

The following steps should be completed on a personal desktop computer with a SanDisk ImageMate or a laptop with a PCMCIA-to-Compact Flash adaptor. To follow this procedure, you must have a CD-ROM drive installed on your personal computer or laptop.



### Warning

During a disk transfer procedure, **do not** remove flashcard before issuing a Stop or shutting down the OS. Otherwise, the last part of the data will not be transferred to the Flashcard.

To reformat a CF card for a model in the PS/PX Series PowerStation, complete the following steps:

1. Start the system, and insert the PS/PX/PC PowerStation Documentation, Utilities, and Drivers CD into your CD-ROM drive of a personal desktop computer or laptop.
2. Select the **Bundled HMI Software Utilities** button from the main menu.
3. Select the **Interact Utilities** button from the sub-menu.
4. Select the **FlashBack Utility** button and follow the instructions.

The FlashBack Utility dialog box will appear.

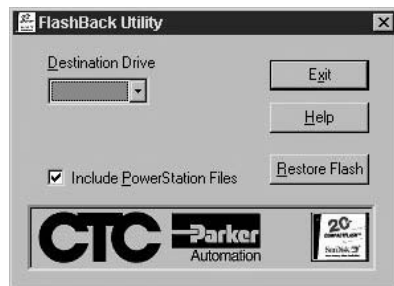

5. Click the **Help** button to find complete, online instructions for using the FlashBack utility.

---

**Note** Make sure that you are using at least revision 104 of the FlashBack utility, which allows the formatting of the CF card even if the boot sector of the CF card is unreadable to DOS.

---

## Maintaining the Display on a PS/PX/PC

---

**Note** If you have an RS/RX/RC system (without display), you may skip this section.

---

This section contains instructions for the following:

- Cleaning the display screen
- Reconfiguring the touchscreen driver
- Recalibrating the touchscreen

### Cleaning the Display Screen

- If you wish to clean the display screen, do so using warm, soapy water and a cloth.
- You also may use any non-abrasive cleaner.
- Do not use any harsh material or powder, such as steel wool or abrasive cleansers.
- See *Faceplate Chemical Resistance* on page 110 for a list of substances the screen can resist with no visible effect.



#### Important

PowerStation users: Do not clean the unit while Interact or InteractX is in Run mode. Clean the unit only when power is off to keep from inadvertently activating a device (button, slide, etc.).

---

If you have a touchscreen monitor, the touchscreen surface is sensitive to scraping, sharp blows, or punctures. Therefore, keep screwdrivers or other sharp objects away from the surface.

### Reconfiguring the Touchscreen Driver

Your system will be shipped with one of the following touchscreen drivers installed and configured. The touchscreen driver installed will depend upon your computer's operating system:

Operating System	Driver
DOS	TouchBase Driver
Windows	Universal Pointing Device Driver (UPDD)

You may have to reconfigure the touchscreen driver if it becomes corrupted, if you reinstall it, or if you wish to change the touchscreen jumper settings in your computer.

This section explains how to reconfigure the touchscreen driver under Windows 98, 2000, XP Pro, NT 4.0, or Embedded NT 4.0, and under MS-DOS (PowerStations only).

#### Reconfiguring under Windows

To configure the touchscreen driver under Windows 98, 2000, NT 4.0 or Embedded NT 4.0, complete the following steps:

1. Select **Start-Programs-UPDD-Settings**.

The Pointer Device Properties window will appear.



2. Select the **Hardware** tab.

The Hardware dialog box will appear as shown below.

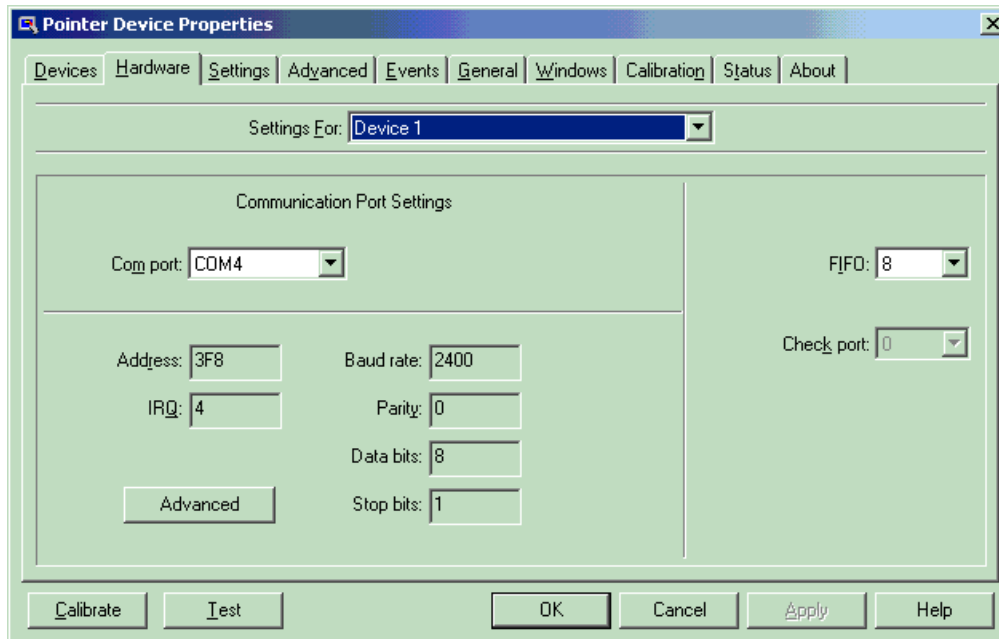

The following table displays the default settings for the touchscreen.

Touchscreen Default Settings	
<b>Port</b>	COM3
<b>Interrupt IRQ</b>	11
<b>Address</b>	3E8

3. Click **OK** when you are finished.
4. Click **OK**.
5. If the changes have no effect, restart the system.

## Reconfiguring under MS-DOS (PS and RS models only)

To configure the touchscreen driver on a system with MS-DOS, complete the following steps:

1. Start the system.

The DOS C:\ prompt will appear.

---

**Note** If the system boots to MachineShop Shell, exit the Shell.

---

2. At the C:\ prompt, type **Edit Autoexec.bat**.

The text of the Autoexec.bat file will appear.

3. Select one of the following:

- If you wish to re-establish the factory default settings for your touchscreen address and IRQ, make sure that the lines near the beginning of the Autoexec.bat file read as follows:

```
SET TOUCH_ADDR=3E8
```

```
SET TOUCH_IRQ=11
```

- If you intend to change the touchscreen settings, change the preceding lines to reflect the new touchscreen address and IRQ.

4. Restart the system.

---

**Note** You must restart the system for your changes to take effect.

---

## Recalibrating the Touchscreen

Your system's touchscreen will be calibrated at the factory. However, you may need to calibrate the touchscreen when you use the system for the first time or whenever the cursor location and the place on the screen where the user touches do not match.

If you are running Windows, you can calibrate the touchscreen under Windows 98, 2000, NT 4.0, or Embedded NT 4.0.

If you are running a PowerStation under MS-DOS, you can calibrate the touchscreen under DOS from the MachineShop Shell.

### Recalibrating under Windows

To recalibrate the touchscreen under Windows 98, 2000, NT 4.0, or Embedded NT 4.0, complete the following steps:

1. Select **Start-Programs-UPDD-Calibrate**.

The following following display will appear:

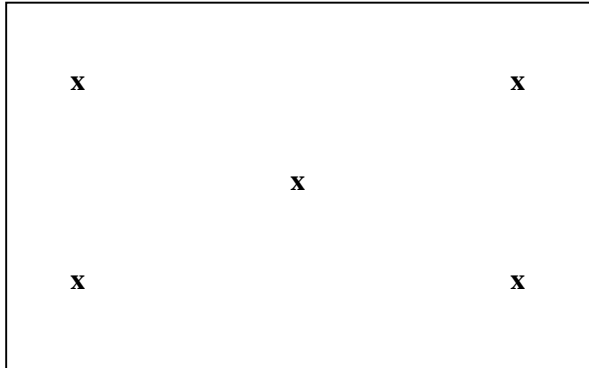

2. Place your finger on the **x** in the upper left corner of the screen.

The **x** will automatically advance to the next corner when you touch it.

3. Touch the **x** in each of the three subsequent corners.

After the calibration is complete, the UPDD calibrate program will automatically close, and return you to the Windows desktop.

---

**Important** If the touchscreen still does not appear calibrated, and the cursor moves vertically when your finger moves horizontally on the screen or vice versa, the touchscreen cable may not be connected to the motherboard properly. Call a CTC customer service representative.

---

## Recalibrating under MS-DOS (PS and PC models only)

To recalibrate the touchscreen under MS-DOS (from the MachineShop Shell), complete the following steps:

**Note** This procedure requires a keyboard.

1. On the MachineShop Shell main menu, press the **SETTINGS** button.

The Settings submenu will appear.

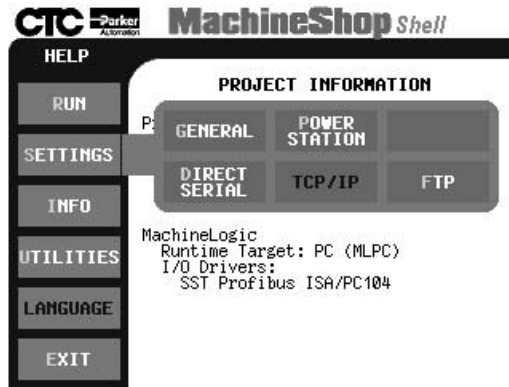

2. Press the **POWER STATION** button.

The PowerStation Settings submenu will appear.

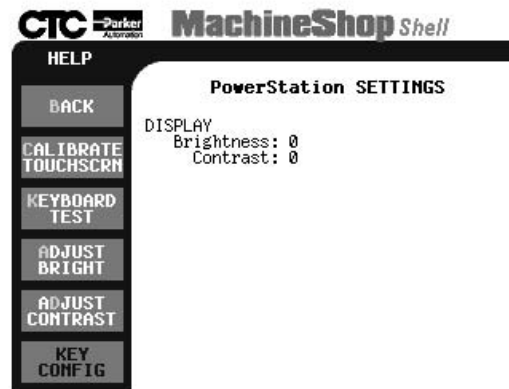

3. On the PowerStation Settings submenu, press the **Calibrate Touchscrn** button.

You will be prompted that a keyboard is needed to calibrate the touchscreen. Then you will be asked if you want to continue.

4. Connect a keyboard to the system, if none is connected.
5. When you have connected a keyboard, press the **Yes** button to continue the calibration.

The Touchscreen Calibration screen will appear.

```
The calibration program will now be started automatically. To
calibrate your touchscreen, perform the following steps in the
calibration program.

- Select "H" to perform a Hard calibration.
- Select "X" to exit the calibration utility
  when finished

Press any key to continue . . .
```

6. Press any key on the keyboard when you are ready to begin calibration.

The Touchscreen Driver Configuration screen will appear.

```
DynaPro Thin Film Products Inc.      (c) Touch-Base Ltd. 1989-2000
Touchscreen Calibration Program (EEPROM version)  Version 4.26

----- Main Menu -----
H - Hard calibrate
T - Test menu
F - Display calib details
X - Exit

You must hard calibrate if you have not yet done so.
```

7. Type **H** for Hard Calibration.

8. Press **Esc** or **X** to exit the calibration utility.



**Important**

After calibrating the touchscreen, enter Interact in Program Mode. Verify that the cursor appears on the screen where you touch. If it does not, recalibrate the touchscreen. The calibration must be accurate to avoid activating a button unintentionally during Run mode.

---

## Performing Internal Maintenance

This section includes important information about performing internal maintenance on the PS/PX/PC PowerStation, including:

- Replacing field-replaceable components
- Observing electrostatic discharge (ESD) precautions
- Opening and closing the system
- Adding expansion cards
- Changing jumper settings

## Replacing Components

The following components are field-replaceable.

- Backlight bulbs
- Battery
- CD-ROM or CD-R/W drive
- Floppy disk drive

- Fuse
- Hard disk drive
- SDRAM modules
- Touchscreen

Instructions for replacing these components can be found on the CTC website [www.ctcusa.com](http://www.ctcusa.com) at the Support web link “Product Manuals”.

We recommend that you order replacement components and installation kits from CTC Parker at 513-831-2340.

Replacement components purchased from CTC are designed and tested to work effectively in your system.

Complete installation instructions are included with each item.

---

**Note** If you wish to purchase replacement components from another source, check the table of *Recommended SDRAM Manufacturers* which appears on page 106.

---

## Observing ESD Precautions

Modern integrated electronic devices, especially circuit cards and memory chips, are extremely sensitive to electrostatic discharges (ESD) and fields. Before you open the system, be sure to follow these simple precautions to protect you and the unit from harm resulting from ESD:



### Electrostatic Discharge Warning

- Always disconnect the power from the PowerStation before opening or disassembling the unit. **Do not** touch any components on the CPU card or other cards while the PowerStation is on.
  - Disconnect power before making any hardware configuration changes. The sudden rush of power as you connect a jumper or install a card may damage sensitive electronic components.
  - Only handle internal components in an ESD-safe location, using appropriate grounding methods.
  - Wear a grounding wrist strap for continuous protection.
  - Always ground yourself to remove any static charge before you touch the CPU card.
  - Do not touch the chip connectors.
  - Keep any card or SDRAM module in its anti-static packaging when it is not installed in the PowerStation. Place it on a static dissipative mat when you are working on it.
-

## Opening and Closing the System

In order to perform internal maintenance on the PowerStations, you will have to access the inside of the workstation. The PowerStations have two main parts: the backshell and the faceplate. The faceplate assembly on the PS/PX/PC models includes the bezel.

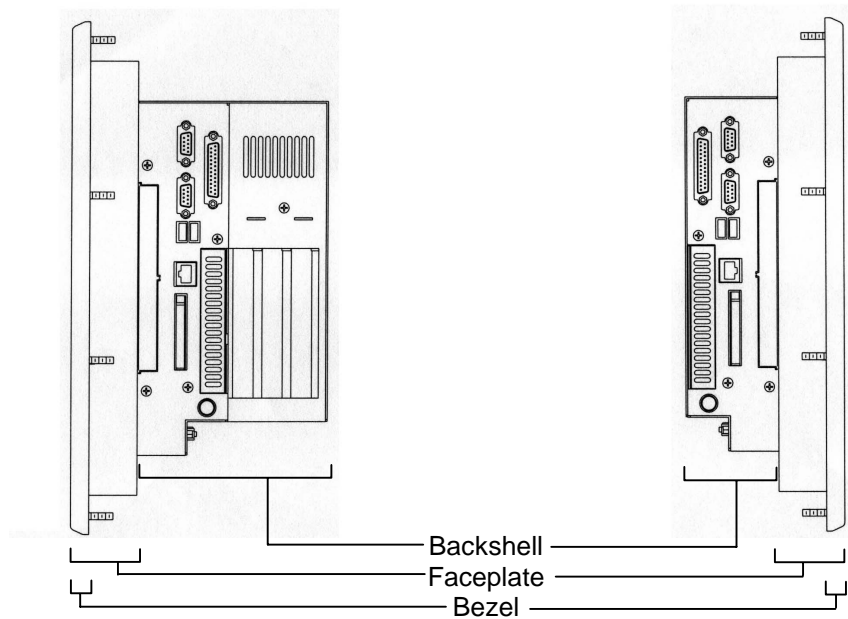

### Opening the system



#### Warning

For safety reasons, the PowerStation should be opened only by qualified service personnel.

### Access the CPU board

To open the backshell and access the CPU board, complete the following steps:

1. Turn off the system.
2. Disconnect the system from the power source.
3. Disconnect all cables attached to the system.
4. Remove the screws from the backplate of the unit (see the illustration below) and set aside.

**Note** The unit illustrated below is a PS15-2. However, the 4 corner screws are located in the same place for all units within the PS/PX/PC PowerStation series regardless of the model number. The PXXX-3/-5 (ISA majority backplate expansion) and PXXX-4/-6 (PCI majority backplate expansion) have an additional fifth screw, indicated in the following illustration by the dashed arrow.

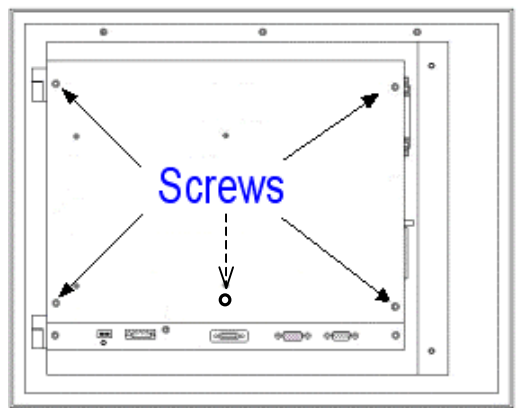

5. If you own a unit with ISA or PCI cards, you will need to remove the bracket that holds the cards in place.

The backplate is removed and the CPU board is accessible.

### Access the hard drive and CD drive area

The area where the hard drive and CD-ROM drive are installed is behind the CPU board. To access this area, separate the backshell from the faceplate by completing the following steps:

1. Complete the steps under **Access the CPU Board** on the previous page, then continue.

For location of each of the cable connectors on the CPU board, see page 18 or 19.

2. Detach the flat panel display cable from the CPU board connector, if the unit is attached to a display. Otherwise, skip to step 5.

3. Detach the function keypad cable, if the unit is attached to a faceplate with a function keypad.

4. Detach the touchscreen cable, if the unit is attached to a display.

5. Detach the CD-ROM drive cable from the CPU board connector, if the unit has a CD-ROM drive.

6. Detach the hard drive cable from the CPU board connector, if the unit has a hard drive.

7. Remove the 6 screws (2 on each of three sides) attaching the backshell to the faceplate and set the screws aside.

---

**Note** The screws are located in the same place for all units within the PS/PX/PC Series PowerStation regardless of the model number - see the white arrows in the illustration below.

---

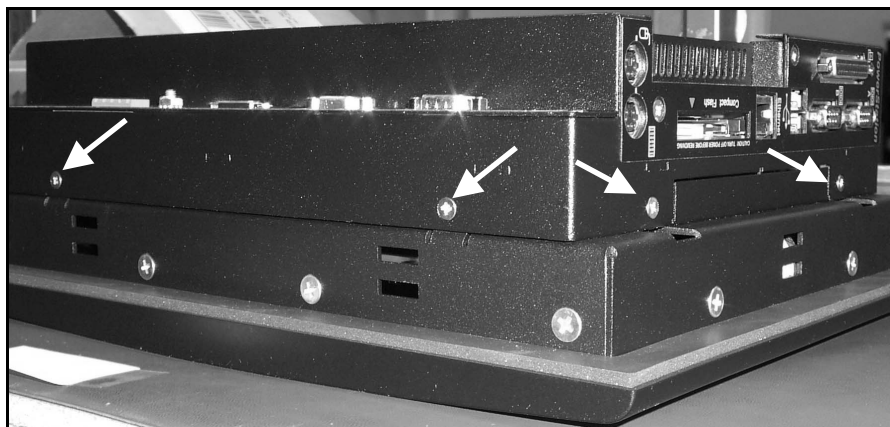

8. Lift the backshell to one side and slide the cables through the slot.

9. Set the backshell aside.

The backshell is removed. The Hard drive/CD-ROM drive area of the backshell is now accessible, as is the faceplate.

### Access the display on the PX50 and PX51

To access the display, complete the following steps:

1. Remove the four corner screws (two on each side) on the transition plate that connect the backshell to the faceplate.



2. Stand the backshell on its side, being aware not to overstretch the cables.
3. For continued work on the display, detach the flat panel cable, the touchscreen cable, and the function keypad cable.

### Access the display on the PX10 models

1. Remove the backplate, see **Access the CPU Board** on page 78.
2. Detach the flat panel cable.
3. Detach the touchscreen cable.
4. Remove the six screws on the two sides and bottom of the backshell, then remove the backshell and set aside.
5. Remove the 12 screws on the sides of the unit that attach the faceplate to the bezel.

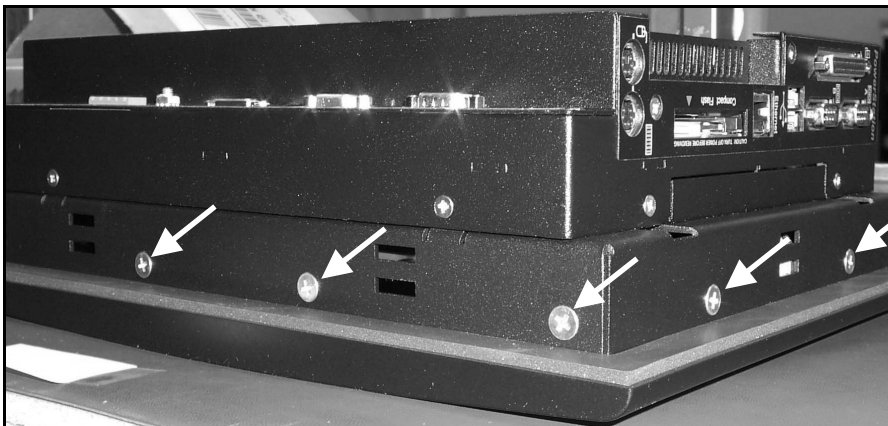



6. Tilt the faceplate to one side and slide the cable through the slot on the faceplate.

---

**Note** Be careful not to disconnect the touchscreen cable from the touchscreen pig tail.

---

7. Set the faceplate aside.

### Access the display on PX12, and PX15 models

1. Remove the backplate, see **Access the CPU Board** on page 78.
2. Detach the flat panel cable.
3. Detach the touchscreen cable.
4. Remove the two screws on the transition plate that connect the backshell to the faceplate assembly.



5. Remove the L-shaped bracket from the hinge.



6. Detach the transition plate and backshell from the hinge by sliding it toward or away from you depending on the position of the unit.
7. Remove the three screws attaching the faceplate to the bezel.

### Closing the system after accessing the display

#### Reassemble the PX50 and PX51

To reassemble after accessing the display, complete the following steps:

1. Reattach the flat panel cable, the touchscreen cable, and the function keypad cable.
2. Place the backshell on the faceplate, being careful not to crimp any cables.
3. Replace the four corner screws on the transition plate that connect the backshell to the faceplate.

### Reassemble the PX10 models

To reassemble after accessing the display, complete the following steps:

1. Slide the cables back through the slots on the faceplate.
2. Place the faceplate on the bezel and reinstall the 12 screws.
3. Place the backshell on the faceplate and reinstall the six screws.
4. Reattach the flat panel cable, and the touchscreen cable to the CPU board.
5. Complete the steps for installing the backplate listed below.

### Reassemble PX12, and PX15 models

To reassemble after accessing the display, complete the following steps:

1. Place the faceplate on the bezel by sliding the tabs of the bezel into the slots on the faceplate.
2. Replace the three screws attaching the faceplate to the bezel.
3. Connect the hinges on the adapter plate to the hinges on the faceplate sliding them into place (the backshell should already be attached to the adaptor plate).
4. Reattach the L-shaped bracket on the hinge.
5. Secure the transition plate and backshell to the faceplate using the two screws previously removed.
6. Attach the flat panel cable, and the touchscreen cable to the CPU board.
7. Complete the steps for installing the backplate below.

## Closing the system after accessing the drive area

### Install the backshell

To install the backshell, complete the following steps:

1. Position the backshell onto the faceplate, making sure the 6 screw tabs on the faceplate are positioned inside the backshell.
2. Attach the backshell using the six screws previously removed from the unit.
3. If using a display, attach the flat panel cable and the touchscreen cable to the board.
4. If using a faceplate with the function keypad, attach the function keypad cable to the board.
5. Continue with the steps below for installing the backplate.

### Install the backplate

To install the backplate on the unit, complete the following steps:

1. If you own a unit that uses ISA or PCI cards, you will need to install the bracket that holds the cards in place.
2. Place the backplate onto the unit.
3. Secure the backplate using the four or five screws removed when disassembling the unit.

The backplate is installed.

## Adding Expansion Cards

The maximum depth for all expansion slots is 11”.

The PXXX-2/RXXX-2 will support up to three PC/104 expansion cards.

The PXXX-3(-5)/RXXX-3(-5) will support any of the following options:

- Three ISA cards
- Two ISA cards and one PCI card

The PXXX-4(-6)/RXXX-4(-6) will support any of the following options:

- Three PCI cards
- Two PCI cards and one ISA card

---

**Note** The PC/104 connector and the ISA or PCI riser card will support either 5V or universal-type expansion cards. They will not support 3.3V cards. As with most ISA bus computer port addresses, 300 through 31F are available for expansion cards. See *I/O Addresses and IRQs* on page 35 for a list of the addresses and IRQs used by the PS/PX/PC Series PowerStation. Make sure that any cards you install do not conflict with these IRQs or addresses.

---

## Adapter cards supported by Interact

If you have a PowerStation (PS or RS), the following table lists PLC expansion cards that can be used with Interact software and the address range for each card.

Do not put all cards at the same address.

In all cases, use the highest address location possible. This will provide contiguous memory for applications.

Driver Name	Address Range	Space Required	Memory Boundary
Allen-Bradley Remote I/O (ABREMIO)	C800 - DFFF	32K	Resides on 32K boundaries
CTC Parker Automation MachineLogic Control Adapter (MLCA) OR MachineLogic Slot Card (MLSC)	C800 - DFFF  D000 is typical for PowerStations (can reside anywhere in UMB)	4, 8, 16, or 32K  16K	Dependent upon "Space Required"  Resides on 16K boundaries
DCSNET PC Link Module (DCSNET)	A000 - FC00	16K	Resides on 16K boundaries
Device Net (DVNT)		16K	Resides on 16K boundaries
GE Fanuc Genius I/O (GENIUS)	C800 - E000	16K	Resides on 16K boundaries
Giddings & Lewis (GLP9)	C000 - E180	2K	Resides on 2K boundaries
Mitsubishi A7BDE (MITS) - MELSECNET and A3N	C800 - DFFF	16K	Resides on 16K boundaries
Mitsubishi A7BDE (MITS) - RS4	C800 - DFFF	8K	Resides on 8K boundaries
Modicon ModBus Plus (MBPL)	C800 - DFFF	2K	Resides on 2K boundaries
OMRON SYSMAC Link (SLNK)	C000 - D800	2K	Resides on 2K boundaries
Opto 22 (MIST)	C000 - E180	2K	Resides on 2K boundaries
Reliance R-NET PC Link Module (RLNT)	C800 - DFFF	16K	Resides on 16K boundaries
Siemens TIWAY (TIWAY)	C000 - E000	4K	Resides on 4K boundaries
Square D SY/MAX Module (SDSL)	CA00 - D300	4K	Resides on 4K boundaries
Sutherland-Schultz SD Adapter (SSSD)	C800 - DFFF	32K	Resides on 32K boundaries
Texas Instruments Remote I/O (TIRIO)	C800 - DFFF	1K	Resides on 1K boundaries

## Plug and Play configuration

If you add an expansion card that is not configured for plug and play (a “legacy” card), you must configure your system in order to avoid resource conflicts:

To reconfigure your system for a legacy expansion card, complete the following steps:

1. Turn on the PowerStation, and before the system boots, press the **F2** key on your keyboard.

The CMOS Setup Utility screen will appear.

2. Using the right arrow key, tab to the **Advanced** menu.
3. Arrow down to **PCI Configuration** and press **Enter**.

The PCI Configuration screen will appear.

PhoenixBIOS Setup Utility	
Advanced	
PCI Configuration	
ISA graphics device installed:	[No]
▶ PCI/PNP ISA UMB Region Exclusion	
▶ PCI/PNP ISA IRQ Resource Exclusion	

4. Use the Down Arrow key to scroll to **PCI/PNP ISA IRQ Resource Exclusion**.

5. Press **ENTER**.

A list of IRQs will be displayed.

6. Highlight the IRQ of the ISA card and change its setting to [**Reserved**].

7. Press **Esc** until the **Save to CMOS and Exit** prompt appears.

8. Select **Y**, and then press **ENTER**.

Your settings will be saved to CMOS, and you will exit the CMOS Setup Utility.

## Changing Jumper Settings

Like other PCs, the PowerStation PS uses jumpers to control some system functions. This section explains how to change jumper settings in order to:

- Enable or disable the Ethernet port
- Change the communication protocol for COM2
- Change the master/slave status of the system’s CF drives
- Clear the system’s CMOS settings



### Important

Other jumpers have been factory set for optimal system performance and should **not** be changed.

### Jumper locations – 266MHz CPU Card

Locations of the PowerStation’s configurable jumpers are shown in the illustration(s) below.

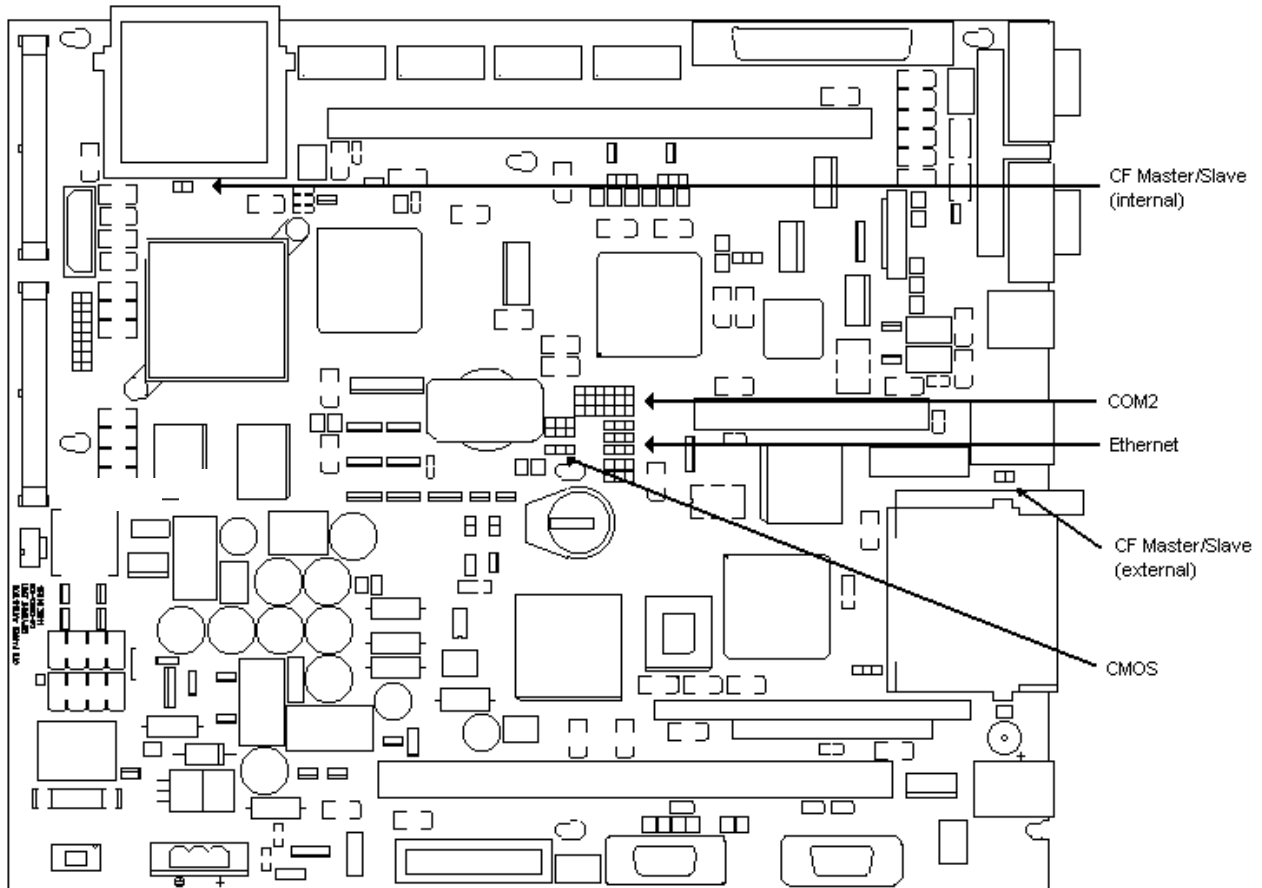

To change jumper settings, first open the backplate (see *Opening the system* on page 78 for instructions). Then follow the procedures outlined in this section. Jumpers set to “on” and “off” should look like those shown below.

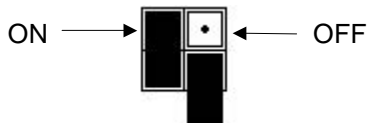

---

**Note** “Off” jumpers can be completely removed or placed as in the illustration above.

---

### Ethernet port - 266MHz CPU Card

The **ENET** jumper controls the Ethernet port (see the configurable jumpers illustration above for this jumper’s location). The default setting, with the Ethernet port enabled, is shown below.

**Enabled (default)**



To disable the Ethernet port, set the jumper as shown below.



## COM2 communication protocol - 266MHz CPU Card

Jumpers that set the communication protocol for COM2 are shown in the configurable jumpers illustration on the previous page. The default protocol for COM2 is RS-485. Jumper settings for this protocol are shown in the following illustration.

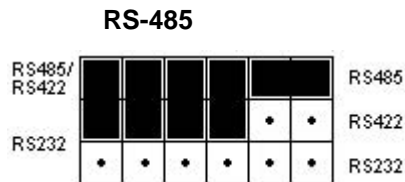

If you want the protocol to be RS-422, set the jumpers as shown below.

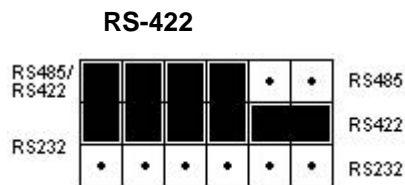

If you want the protocol to be RS-232, set the jumpers as shown in the illustration on the following page.

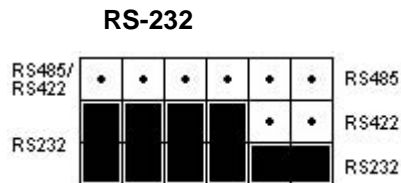

---

**Note** See also *Serial Ports* on page 27. For pinout information on all three serial ports, see *COM1, 2, and 3 pinouts* on page 28.

---

## Internal CF master/slave status - 266MHz CPU Card

Jumpers **E7** and **E8** determine whether the internal CF card operates as a master or slave drive. The location of these jumpers is shown on page 86.

---

**Note** The internal Compact Flash will compete with the hard drive as master or slave. You will need to set a designation.

---

When the internal CF is the master drive, the jumper is “On,” as shown in the following illustration.

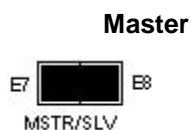

When the internal CF is a slave, the jumpers should be “Off,” as shown below.

**Slave****External CF master/slave status - 266MHz CPU Card**

Jumpers **E70** and **E71** determine whether the external CF card operates as a master or slave drive. The location of these jumpers is shown in the illustration on page 86.

---

**Note** The external Compact Flash will compete with the CD ROM drive as master or slave. You will need to set a designation.

---

When the external CF is the master drive, the jumpers are “On,” as shown below.

**Master**

When the external CF is a slave, the jumpers should be “Off,” as shown below.

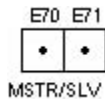
**Slave****CMOS settings - 266MHz CPU Card**

Jumpers **E52**, **E53**, and **E54** enable you to clear the computer’s CMOS settings. The location of these jumpers is shown in the illustration on page 86. The default setting for these jumpers is shown below.

**Default**

To clear the CMOS settings, complete the following steps:

1. Set the jumpers as shown below.



2. Wait a few seconds.
3. Reset the jumpers to the default settings.



## Jumper locations – 566MHz/1GHz CPU Card

Locations of the PowerStation’s configurable jumpers are shown in the illustration(s) below.

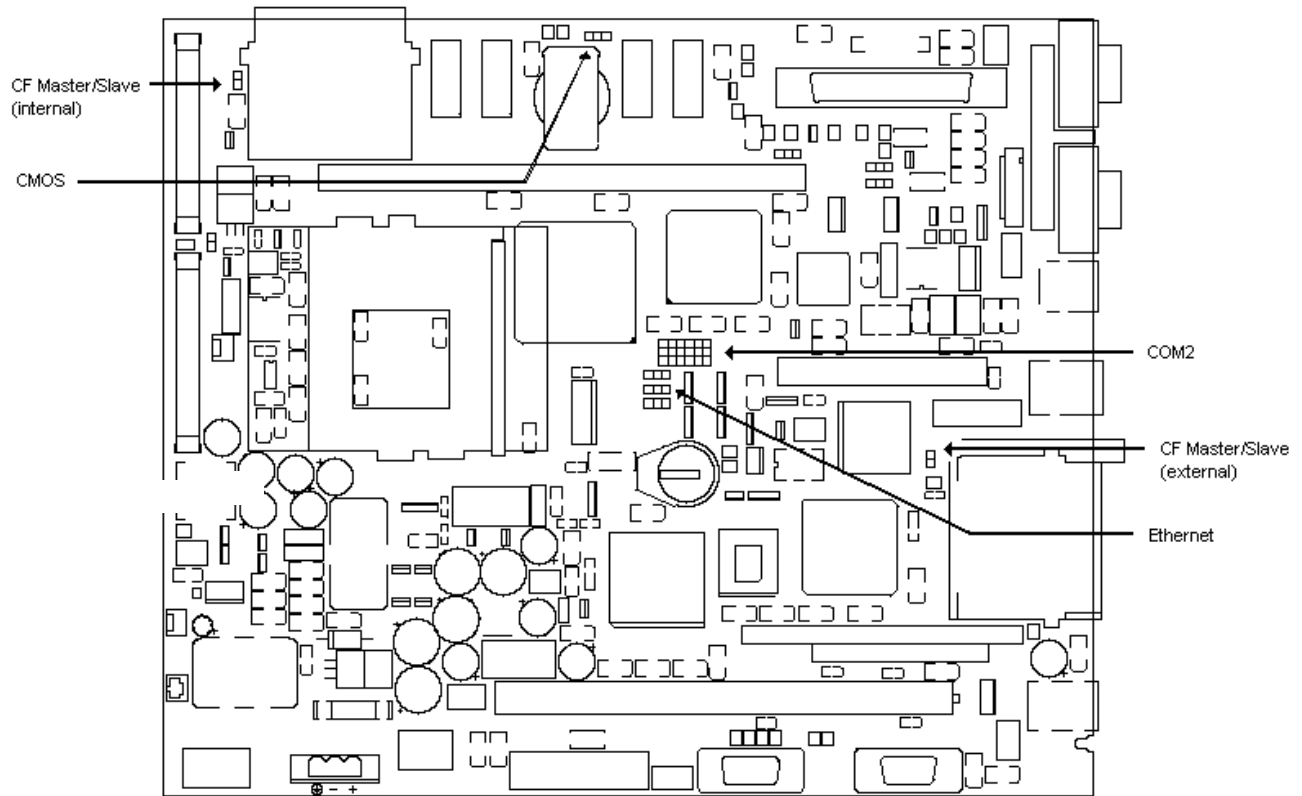

To change jumper settings, first open the backplate (see *Opening the system* on page 78 for instructions). Then follow the procedures outlined in this section. Jumpers set to “on” and “off” should look like those shown below.

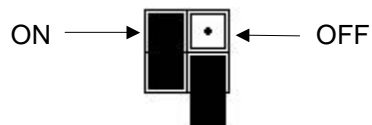

---

**Note** “Off” jumpers can be completely removed or placed as in the illustration above.

---

## Ethernet port - 566MHz/1GHz CPU Card

The **ENET** jumper controls the Ethernet port (see the configurable jumpers illustration above for this jumper’s location). The default setting, with the Ethernet port enabled, is shown below.

**Enabled (default)**

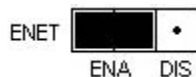

To disable the Ethernet port, set the jumper as shown below.

**Disabled**

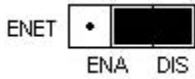

**COM2 communication protocol - 566MHz/1GHz CPU Card**

Jumpers that set the communication protocol for COM2 are shown in the configurable jumpers illustration on the previous page. The default protocol for COM2 is RS-485. Jumper settings for this protocol are shown in the following illustration.

**RS-485**

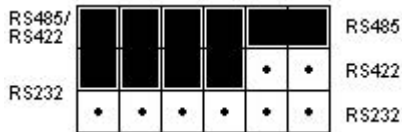

If you want the protocol to be RS-422, set the jumpers as shown below.

**RS-422**

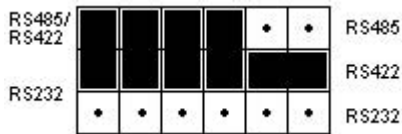

If you want the protocol to be RS-232, set the jumpers as shown below.

**RS-232**

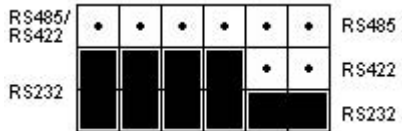

---

**Note** See also *Serial Ports* on page 27. For pinout information on all three serial ports, see *COM1*, *2*, and *3 pinouts* on page 28.

---

**Internal CF master/slave status - 566MHz/1GHz CPU Card**

Jumpers **E4** and **E5** determine whether the internal CF card operates as a master or slave drive. The location of these jumpers is shown on page 86.

---

**Note** The internal Compact Flash will compete with the hard drive as master or slave. You will need to set a designation.

---

When the internal CF is the master drive, the jumper is “On,” as shown in the following illustration.

**Master**

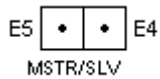

When the internal CF is a slave, the jumpers should be “Off,” as shown below.

**Slave****External CF master/slave status - 566MHz/1GHz CPU Card**

Jumpers **E44** and **E45** determine whether the external CF card operates as a master or slave drive. The location of these jumpers is shown in the illustration on page 86.

---

**Note** The external Compact Flash will compete with the CD ROM drive as master or slave. You will need to set a designation.

---

When the external CF is the master drive, the jumpers are “On,” as shown below.

**Master**

When the external CF is a slave, the jumpers should be “Off,” as shown below.

**Slave****CMOS settings - 566MHz/1GHz CPU Card**

Jumpers **E1**, **E2**, and **E3** enable you to clear the computer’s CMOS settings. The location of these jumpers is shown in the illustration on page 86. The default setting for these jumpers is shown below.

**Default**

To clear the CMOS settings, complete the following steps:

1. Set the jumpers as shown below.



2. Wait a few seconds.
3. Reset the jumpers to the default settings.



# CHAPTER 5: TROUBLESHOOTING

This chapter provides basic troubleshooting steps to help you identify and correct problems that you may have with your PS/PX/PC Series PowerStation. Each problem is described, followed by one or more possible solutions.

## Chapter Contents

---

<i>Troubleshooting Instructions</i>	94
<i>Problems When Starting</i>	95
<i>Problems Signaled by PowerSmart</i>	97
<i>Problems with Displays</i>	99
<i>Problems with Touchscreens</i>	99
<i>Problems with Peripheral Devices</i>	100

## Troubleshooting Instructions

This chapter provides basic troubleshooting steps to help you identify and correct problems that you may have with your PS/PX/PC Series PowerStation. Each problem is described, followed by one or more possible solutions. Begin with the first solution, and continue until you have solved the problem or exhausted the possible solutions.

If you cannot solve the problem yourself, or if you have a problem that is not documented here, contact your CTC Parker distributor, check the Support page on the CTC website [www.ctcusa.com](http://www.ctcusa.com), or call our Technical Support department at 513-248-1714.

Use the following table to find discussions of specific problems.

<b>Problem</b>	<b>Page</b>
<b>Problems When Starting</b>	
System does not start; the display is blank.	95
The RAM test fails, or the total memory installed does not match the total contiguous RAM listed in the display following the RAM test.	95
The system locks up while starting and will not restart (PS/PX/PC only).	96
The DOS prompt is displayed instead of the MachineShop Shell main menu (PS/RS only).	96
Autoexec.bat and Config.sys problems (PS/RS only).	97
<b>Problems Signaled by PowerSmart</b>	
An error condition exists for a power supply voltage.	97
An error condition exists for a temperature.	98
An error exists for a fan.	98
PowerSmart display shows a COMM ERROR.	98
<b>Problems with Displays</b>	
The top or bottom half of the screen looks dark.	99
After startup, the touchscreen is blank.	99
<b>Problems with Touchscreens</b>	
After startup, the touchscreen does not work properly, or touchscreen calibration is incorrect.	99
After calibrating the touchscreen, it either does not work or does not follow your finger.	100
<b>Problems with Peripheral Devices</b>	
A PS/2 mouse does not work.	100
A keyboard does not work.	100
The function keypad does not work	101
The Ethernet port does not work.	101
A driver does not work with the installed adapter card.	101

## Problems When Starting

Some of the most common problems that users encounter with PC's occur when they start their systems. This section discusses problems that may occur during startup.

### System does not start; the display is blank

1. Turn off the system.
2. Make sure that the power cord is firmly plugged into both the system and the power source.
3. Restart the system.

If the display does not come on, continue with step 4.

4. Turn off the system.
5. Disconnect the system from the power source.
6. Open the backplate, following the procedure in *Opening the system* on page 78.
7. Make sure that the video cable is firmly connected.
8. Make sure that the SDRAM modules are firmly seated in their sockets and that the socket latches are fully engaged.
9. Make sure that all cards are firmly seated.
10. Close the system, following the procedure in *Closing the system* on page 81.
11. Reconnect the system to the power source.
12. Restart the system.

### The RAM test fails, or the total memory installed does not match the total contiguous RAM listed in the display following the RAM test

---

**Note** The CPU board contains 32M (64M on 566MHz and 1GHz CPU cards) of memory. You must add the same amount of memory to the SDRAM stick.

---

1. Turn off the system.
2. Disconnect the system from the power source.
3. Open the backplate, following the procedure in *Opening the system* on page 78.
4. Re-seat the SDRAM module on the CPU card.

Make sure that the module is firmly seated in its socket and that the socket latches are fully engaged.

5. Close the system, following the procedure in *Closing the system* on page 81.
6. Reconnect the system to the power source.
7. Restart the system.

### The system locks up while starting and will not restart (PS/RS only).

1. Turn off the system.
2. Connect a keyboard to the system.
3. Restart in MS-DOS mode.
4. When the message Starting MS-DOS appears, press the **F8** key.

This will cause the system to step through the Autoexec.bat and Config.sys files line-by-line.

---

**Note** If the **Starting MS-DOS** message does not appear, go to step 7.

---

---

**Note** Use the **DOS copy** command to overwrite the corrupted file.

---

5. Step through the Autoexec.bat and Config.sys files until you find the cause of the lockup.
6. Restart the system to see if the problem has been solved.
7. If the system locks up before the Starting MS-DOS message appears, restart the unit, and press the F2 key to enter the BIOS setup program.
8. In the **Exit** menu, select the **Load Setup Defaults** option.
9. Selecting this option will restore the BIOS settings to their factory default configuration.
10. In the **Advanced** menu, change the **Reset Configuration Data** to **Yes**.
11. When the system restarts, this setting will automatically switch back to No.
12. Save these settings, and exit the setup program.
13. Restart the system.

### The DOS prompt is displayed instead of the MachineShop Shell main menu (PS/RS only).

1. Restart the system.
2. If the problem persists, turn off the system.
3. Connect a keyboard to the unit.
4. Restart the system.
5. When the message **Starting MS-DOS** appears, press the **F8** key.

This will cause the system to step through the Autoexec.bat and Config.sys files line-by-line.

6. The Autoexec.bat file may have been corrupted or modified.

---

**Note** Use the **DOS copy** command to overwrite the corrupted file.

---

7. Verify that the following lines (which load the MachineShop Shell) appear at the end of the Autoexec.bat file and do not have the word **REM** in front of them:

```
CD \CTC  
PSU
```

8. Restart the system.



## Autoexec.bat and Config.sys problems (PS/RS only)

In the PS/RS workstations, some startup problems might be caused by a corrupted or modified Autoexec.bat or Config.sys file. Backup copies of these files (Autoexec.ctc and Config.ctc) are included on the hard drive in the directory \ctc\ shipped with your system.

If you suspect a problem with the Autoexec.bat or Config.sys file, use the **DOS copy** command to create a backup copy of your current file. Then overwrite the suspect file with the backup. The backup files are located in the \ctc\ directory. For example, if the Autoexec.bat file is suspect, type the following commands at the DOS prompt:

```
copy autoexec.bat autoexec.old
copy \ctc\autoexec.ctc autoexec.bat
```

For further information, check the Support page on CTC's website at [www.ctcusa.com](http://www.ctcusa.com).

## Problems Signaled by PowerSmart

The PS/PX Series PowerStation comes with the exclusive PowerSmart system monitor that keeps track of the unit's power supply output voltage, internal temperature, cooling fan speeds, and hours of operation. It also signals communication errors by any of PowerSmart's monitoring devices. See *PowerSmart* on page 32 for information about how the PowerSmart utility works.

The following table shows the values monitored by PowerSmart.

Parameter	Nominal Value	Minimum Value	Maximum Value
Internal temperature	N/A	N/A	65°C
Cooling fan speeds	4800 – 5800 RPM	3000 RPM	N/A
3.3V power supply	3.3 VDC	3.0 VDC	3.6 VDC
5V power supply	5.0 VDC	4.75 VDC	5.5 VDC
12V power supply	12.0 VDC	11.5 VDC	12.5 VDC
-5V power supply	-5.0 VDC	-5.5 VDC	-4.75 VDC
-12V power supply	-12.0 VDC	-12.5 VDC	-11.5 VDC

If any of the system's voltage, fan speed, or temperature parameters is out-of-limit, the PowerSmart display will change color, and the gauges will show the error condition.

If the display has been minimized, the PowerSmart button on the Windows taskbar will flash continually.

Click the button to show the display.

The remainder of this section explains how to respond if PowerSmart indicates that any parameters are out of limit.

### An error condition exists for a power supply voltage

If the power supply shows low voltage, make sure that any expansion cards installed do not exceed the recommended power supply load limit (see *Electrical Specifications* on page 109 for this parameter).

Use a voltmeter to measure the power supply.

If the voltmeter confirms the error, contact our Technical Support department at 513-248-1714 about

replacing the power supply.

### An error condition exists for a temperature

1. Make sure that any expansion cards installed do not exceed the recommended power supply load limit (see *Electrical Specifications* on page 109 for this parameter).
2. Make sure that the maximum rated ambient temperature for the system has not been exceeded (see *Electrical Specifications* on page 109 for this parameter).

### An error exists for a fan

1. Make sure there is no foreign matter obstructing the fan blades.
2. Make sure the fan power harness has not come loose or is frayed.

### The PowerSmart display shows a COMM ERROR

When a communications error occurs in a monitoring device, the **Comms Status** light in the PowerSmart display will change from green to red, and a dialog box, like the one below, will appear describing the error. Information provided by the device will not display.



If the microcontroller fails, no information will display on any gauge because the microcontroller decides what information to display.

---

**Note** If the Comms Status light is red, but no dialog box appears, click on the light to see the COMM ERROR.

---

1. Check for loose or shorted pins on the PowerSmart peripheral device showing the error.

The devices and their locations are shown below. See *PowerSmart* on page 34 for a description of the devices' functions.

Device	Location (266MHz board)	Location (566MHz/1GHz board)
Microcontroller (87LPC764)	CPU card U38	CPU card U23
Peripheral monitor (DS1780)	CPU card U41	CPU card U37
EEPROM (24C02)	CPU card U39	CPU card U21

2. Contact our Technical Support department at 513-248-1714 about replacing the device showing the error.

## Problems with Displays

### The top or bottom half of the screen looks dark

One of the backlight bulbs may be burned out. Replace both backlight bulbs.

Contact your CTC Parker distributor or CTC Customer Support to order a Backlight Bulb Replacement Kit.

### After startup, the display is blank

This problem could occur if the connection to the power or video cable is interrupted. Complete the following steps to check the power. If the problem still exists, follow the procedure for checking the video cable.

#### Check the power

1. Turn off the system.
2. Make sure the power cord is firmly plugged into both the system and the power source.
3. Restart the system.

#### Check the video cable

1. Turn off the system.
2. Disconnect the system from the power source.
3. Open the backplate. See *Opening the system* on page 78 for instructions.
4. Make sure that the video cable is firmly connected.
5. Close the system. See *Closing the system* on page 81 for instructions.
6. Reconnect the system to the power source.
7. Restart the system.

## Problems with Touchscreens

This section discusses problems that may occur in systems that have a touchscreen display. If you do not have a touchscreen, skip this section.

### After startup, the touchscreen does not work properly, the touchscreen does not load, or touchscreen calibration is incorrect

- You may need to reconfigure or recalibrate the touchscreen.

See *Reconfiguring the Touchscreen Driver* on page 72 and *Recalibrating the Touchscreen* on page 74 for instructions.

- Restart the system.

#### PS/PC only

1. If the problem persists, turn off the system.
2. Connect a keyboard to the unit.
3. Restart in MS-DOS mode.

4. When the message **Starting MS-DOS** appears, press the **F8** key.
5. This will cause the system to step through the Autoexec.bat and Config.sys files line-by-line.
6. Verify that the following lines appear in the Autoexec.bat file before the lines that load the touchscreen driver:

```
IF EXIST C:\CTC\MOUSE.INI DEL C:\CTC\  
MOUSE.INI  
LH C:\CTC\MOUSE
```

7. Verify that the touchscreen drivers are being loaded.

Look in the Autoexec.bat file for the following lines:

```
SET TOUCH_PATH=C:\TOUCH  
CALL %TOUCH_PATH%\TCHINIT.BAT
```

---

**Note** Use the **DOS copy** command to overwrite a corrupted Autoexec.bat file.

---

8. If you have changed the BIOS settings for your touchscreen address or IRQ, locate the following lines near the beginning of the Autoexec.bat file, and change them to reflect your new settings:

```
SET TOUCH_ADDR=3E8  
SET TOUCH_IRQ=11
```

### **After calibrating the touchscreen, it either does not work or does not follow your finger**

1. Open the unit following the procedure on page 78.
2. Make sure that the touchscreen cable is properly connected.
3. Close the unit following the procedure on page 81.
4. If the touchscreen cable is damaged, replace the touchscreen cable.

Contact our Technical Support department at 513-248-1714 to order a new touchscreen cable.

## **Problems with Peripheral Devices**

This section discusses problems that may occur after startup.

### **A PS/2 mouse does not work**

1. Make sure that you are using a Microsoft PS/2 mouse.

Some PS/2 mice that claim to be Microsoft-compatible will not work correctly with the PS/PC. Do not use a serial mouse with a serial-to-PS/2 port adapter.

2. Make sure that your mouse is plugged into the PS/2 mouse port.
3. Try using a new PS/2 mouse.

### **A keyboard does not work**

1. Make sure the keyboard is an AT-compatible keyboard, not an XT keyboard.
2. Make sure that your keyboard is plugged into the PS/2 keyboard port.

---

**Note** If you have a PX50 or PX51, then the keyboard will be plugged into the faceplate.

---

3. Try using a new keyboard.

### The function keypad does not work

Open the PowerStation, see page 78, and check the following:

1. The function keypad cable is plugged in to the function keypad cable socket.
2. The cables have not been crimped.

### The Ethernet port does not work

1. Make sure that the Ethernet cable is securely plugged into the Ethernet port.

#### PS/PX/PC only

2. If the problem persists, turn off the system.
3. Connect a keyboard to the unit.
4. Restart in MS-DOS mode.
5. When the message Starting MS-DOS appears, press the **F8** key.

This will cause the system to step through the Autoexec.bat and Config.sys files line-by-line.

6. Make sure that the networking software is being loaded.

Specifically, verify that the following lines appear in the Autoexec.bat file and do not have the word **REM** in front of them:

```
CD \NET
```

```
CALL C:\NET\NET.BAT
```

### A driver does not work with the installed adapter card

- Make sure that there are no interrupt or memory conflicts with other adapter cards.

See *Adding Expansion Cards* on page 83 for a list of I/O addresses available to expansion cards. See *I/O Addresses and IRQs* on page 35 for the addresses and IRQs used by the system.

#### PS/PC only

- Make sure that the adapter card is supported by the PS/PC.

See *Adding Expansion Cards* on page 83 for a list of adapter cards that the PS Series PowerStation will support and their memory locations.

---

**Note** For additional information about adapter cards supplied by CTC Parker, see the Windows help file for your Interact device driver(s) or your I/O driver help file(s). These help files will be accessible from the MachineShop toolbar.

---



# APPENDIX A: SPECIFICATIONS

This appendix lists specifications for all models in the PS/PX/PC Series PowerStation unless otherwise indicated.

## **Contents**

---

<i>Physical Specifications</i>	104
<i>Recommended SDRAM Manufacturers</i>	106
<i>Operating Systems Supported</i>	106
<i>Display Specifications</i>	107
<i>Environmental Specifications</i>	108
<i>Electrical Specifications</i>	109
<i>Testing Specifications</i>	109
<i>Faceplate Chemical Resistance</i>	110
<i>Agency Approvals</i>	111

## Physical Specifications

### PS/PX/PC Series PowerStation Specifications

Category	Specifications for Standard Line
Dimensions (H x W x D)	See dimensional drawings for each model
Weight	<ul style="list-style-type: none"> <li>• PS10-2: 13.9 lbs.</li> <li>• PS10-3, -4: 15.5 lbs.</li> </ul>
	<ul style="list-style-type: none"> <li>• PS12-2: 21.0 lbs.</li> <li>• PS12-3, -4: 22.6 lbs.</li> </ul>
	<ul style="list-style-type: none"> <li>• PS15-2: 24.4 lbs</li> <li>• PS15-3, -4: 26.0 lbs</li> </ul>
	<ul style="list-style-type: none"> <li>• PS18-2: 28.46 lbs</li> <li>• PS18-3, -4: 30.54 lbs</li> </ul>
	<ul style="list-style-type: none"> <li>• Floppy Drive: 2.0 lbs.</li> </ul>
Processor	Intel® Pentium MMX™ 266MHz, 66MHz host bus frequency Intel® Celeron™ 566MHz, 66MHz host bus frequency Intel® Pentium III™ 1.0GHz, 100MHz host bus frequency
Memory	32MB SDRAM (4 chips) is soldered on the 266MHz CPU card. 64MB SDRAM (4 chips) is soldered on the 566MHz and CPU card. In addition, one DIMM socket supports up to 256MB of SDRAM. <hr/> <b>Note:</b> A minimum of 128MB SDRAM is recommended for systems running Windows 2000. If you need to replace SDRAM, see <i>Recommended SDRAM Manufacturers</i> on page 106.
Cache	512K level-two cache
Storage	<ul style="list-style-type: none"> <li>• Two on-board Compact Flash (CF) slots. External CF slot has CF card ejector</li> <li>• 10GB or higher hard drive (optional)</li> <li>• CD-ROM drive (optional)</li> <li>• CD-R/W drive (optional)</li> <li>• 1.44MB high-density floppy drive (optional, external)</li> </ul>
Peripheral interfaces	<ul style="list-style-type: none"> <li>• Three 16550 serial ports               <ul style="list-style-type: none"> <li>◦ Two 9-pin serial RS-232 ports</li> <li>◦ One 9-pin RS-232/422/485 configurable port</li> </ul> </li> <li>• One internal for the touchscreen controller</li> <li>• One 25-pin bi-directional parallel port, supports SPP, EPP, and ECP</li> <li>• Two PS/2 ports               <ul style="list-style-type: none"> <li>◦ Keyboard</li> <li>◦ Mouse</li> </ul> </li> <li>• Two USB ports</li> </ul> <hr/> <b>Note:</b> DOS and Windows NT 4.0 <b>do not</b> support USB ports
	<ul style="list-style-type: none"> <li>• One RJ45 Ethernet port, 10Base-T/100Base-TX (See "Ethernet Controller" below)</li> </ul>



Category	Specifications for Standard Line
	<ul style="list-style-type: none"> <li>• Video port (see “Video” in this table, below)</li> <li>• Integrated, dual-channel EIDE interface</li> <li>• Support for up to four IDE devices</li> <li>• PIO Mode 4 transfers at up to 16MB/sec</li> <li>• Support for Ultra DMA/33 synchronous DMA mode transfers at up to 33MB/sec</li> <li>• Bus master mode with an 8 x 32-bit buffer for bus master PCI IDE burst transfers</li> <li>• On-board resistive touchscreen controller</li> </ul>
Ethernet Controller	<ul style="list-style-type: none"> <li>• Intel 82559 PCI 10BASE-T/100BASE-TX Interface Ethernet controller</li> <li>• RJ45 interface <ul style="list-style-type: none"> <li>◦ Integrated IEEE 802.3 10BASE-T and 100BASE-TX compatible PHY</li> <li>◦ System Management Bus (SMB) support for advanced management support</li> <li>◦ PCI power management specifications compliance</li> <li>◦ Full duplex support at both 10 and 100 Mbps operation</li> <li>◦ IEEE 802.3u auto-negotiation support</li> <li>◦ 3K Transmit FIFO and 3K Receive FIFO</li> <li>◦ Back-to-back transmission support with minimum interframe spacing</li> <li>◦ IEEE 802.3x 100BASE-TX Flow Control support\</li> </ul> </li> </ul>
Video	<ul style="list-style-type: none"> <li>• Intel, CHIPS 69000 HiQVideo™ Accelerator (266MHz CPU board)</li> <li>• Intel, CHIPS 69030 HiQVideo™ Accelerator (566MHz – 1GHz CPU board)</li> <li>• 2MB (266MHz CPU board) or 4MB (566MHz – 1GHz CPU board) of high-speed SDRAM on chip-frame buffer</li> <li>• Analog video is supported via an industry-standard SVGA 15-pin Sub-D connector located on the rear panel</li> </ul>
Touchscreen	<ul style="list-style-type: none"> <li>• A serial touchscreen controller is used to interface to the Touchscreen</li> <li>• The touchscreen is connected to the ISA bus through the 16C552 UART, designated as COM3</li> <li>• I/O resources for the touchscreen are BIOS</li> <li>• The IRQ choices are IRQ3, IRQ4, IRQ9, IRQ11</li> </ul>
Expansion slots	<ul style="list-style-type: none"> <li>• PC/104 expansion up to three cards</li> <li>• ISA PCI riser card connector for expansion up to three ISA or three PCI with three PCI masters</li> <li>• ISA bus—16-bit, supports the IEEE ISA standard, up to 8.333MHz</li> <li>• PCI bus (rev. 2.2)—supports the 33MHz 32-bit, PCI bus architecture</li> </ul>
BIOS	<p>Phoenix BIOS is located in the 256K boot-block FLASH EPROM. Standard features include:</p> <ul style="list-style-type: none"> <li>◦ FLASH/EPROM-based setup utility</li> <li>◦ Power-On Self-Test (POST)</li> <li>◦ Password protection</li> <li>◦ Advanced Power Management</li> <li>◦ System plug and play support</li> </ul>

Category	Specifications for Standard Line
Additional Features	<ul style="list-style-type: none"> <li>• Real-time clock with battery backup</li> <li>• APC (Advanced Power Supply) control</li> <li>• Integrated 24VDC-input power supply</li> <li>• CTC Parker's software security key socket</li> <li>• CTC Parker's PowerSmart hardware support</li> <li>• "Sticky IDE" feature</li> <li>• Beeper</li> <li>• Watchdog Timer <ul style="list-style-type: none"> <li>◦ Includes a software-enabled/disabled watchdog timer</li> <li>◦ Generates a system reset when triggered</li> <li>◦ Timeout interval ranges from 1 to 62 seconds</li> <li>◦ Can be set by writing an I/O port address</li> </ul> </li> </ul>

## Recommended SDRAM Manufacturers

Available Sizes	Manufacturer	Product Number
256MB	Hyundai	HYM71V653201
256MB	Toshiba	THMY6432G1EG-80
128MB	Hyundai	HYM7V651601BTRG-10S
128MB	Micron	MT8LSDT1664AB-10EB1
128MB	SEC	KMM374S1623BT-GLQ
64MB	Hyundai	HYM7V65801BTRG-10S
64MB	Micron	MT4LSDT864AG-10EB1
64MB	Toshiba	THMY6480F1BEG-80
32MB	Hyundai	HYM7V65401BTRG-10S
32MB	Micron	MT4LSDT464AG-10EC6
32MB	SEC	KMM374S403CT-GL
32MB	SEC	KMM374S823BT-GLQ

## Operating Systems Supported

The PS/PC/RS/RC supports the operating systems listed below
MS-DOS 6.xx
Windows 98
Windows 2000
Windows NT 4.0
Windows Embedded NT 4.0
Windows XP Pro

## Display Specifications

### Display Options

The PS/PX/PC comes with the display options shown in the following table. Each display can be ordered with or without a touchscreen, and each can show up to 262,144 colors.

PowerStation/PC	Display Size	Resolution	Color	Type
PS10, PC10	*9.4"	VGA (640 x 480)	Mono	LCD
	10.4"	VGA (640 x 480)	Color	TFT
	10.4"	VGA (640 x 480)	Bright Color	TFT
PS12, PC12	12.1"	SVGA (800 x 600)	Color	TFT
PS15, PC15	15.1"	XGA (1024 x 768)	Color	TFT
PS18, PC18	18.1"	SXGA (1280 x 1024)	Color	TFT
RS, RC	No display			

\*Available with the PS10 model only

---

**Note** PSs and PCs with 12.1" and 15.1" displays have a special card installed that enables them to display Interact screens at 640 x 480 VGA resolution.

---

### Brightness, and Backlight Lifetime

Category	Display Type	Specifications
Brightness	9.5" Mono	110 nits
	10.4" TFT Color	200 nits
	10.4" Bright TFT Color	350 nits
	12.1" TFT Color	300 nits
	15.1" TFT Color	200 nits
	18.1" TFT Color	235 nits
Backlight lifetime	9.5" Mono	10,000 hours
	10.4" TFT Color	50,000 hours
	10.4" Bright TFT Color	50,000 hours
	12.1" TFT Color	50,000 hours
	15.1" TFT Color	50,000 hours
	18.1" TFT Color	50,000 hours

## Environmental Specifications

Category	Specifications
Operating temperature	41° to 122° F (5° to 50° C) ambient air temperature
Storage temperature	-4°F to 158°F(-20° to 70° C)
Relative humidity	5% to 95% non-condensing
Altitude	-200ft. to 10,000ft. (-60.96m to 3,048m)
Shock rating	10g, 11ms operating 30g, 11ms non-operating
Vibration rating	0.5g rms from 10 to 500Hz operating (hard drive) 1.0g rms from 10 to 500Hz non-operating With CD-ROM or CD-R/W drive, 0.2g rms With Compact Flash card, 1g rms from 10 to 500Hz operating
Faceplate designed for	Type 4/4X environment <hr/> <b>Note</b> The unit is only rated for a 4/4X environment if it is mounted in an enclosure that is rated NEMA 4/4X.



### Important

Limit the system's exposure to adverse conditions, such as dust, oil, moisture, and corrosive vapors in order to minimize maintenance and repair costs.

Remember that the temperature within a protective enclosure is generally higher than the external temperature. Thus, if the system is operating inside an enclosure, at temperature levels above its rated ambient temperature, you must cool the enclosure.

## Electrical Specifications

The PS/PX/PC Series PowerStation accepts DC input only. To apply AC power, you must use an AC adapter.

**Note** You can purchase an AC adapter from CTC Parker Automation at 513-831-2340.

Electrical specifications for the system are listed in the table below.

Category	Unit Specifications
Input voltage	24VDC nominal @ 4.5A 24VDC surge @ 12A for 10mS (worst case) Input voltage range: 18VDC-28VDC
Fuse type	250VAC Littlefuse, part #216.315, field-replaceable (266MHz CPU board) 250VAC Littlefuse, part #216.008, field-replaceable (566MHz - 1GHz CPU board) 5A max. overcurrent protection (266MHz CPU board) 8A max. overcurrent protection (566MHz or 1GHz CPU board)
Expansion slots	Voltage and total current available for expansion cards are as follows: 3.3VDC @ 1A 5VDC @ 1.5A 12VDC @ 0.5A -5VDC @ 0.075A -12VDC @ 0.15A



### Important

The system's power supply automatically detects the input voltage level and adjusts accordingly. However, always use reliable sources of power, and isolate all communication cables from power lines to enhance noise immunity.

## Testing Specifications

Testing Criteria	Classification
Showering arc	NEMA showering arc
Surge withstanding capacitance	EN61000-4-5
ESD requirements	EN61000-4-2
Operating temperature	IEC 68-2-1
Electrical fast transient	EN61000-4-4
European Harmonized EAC Standards	EN50082-2, EN55011
Operating vibration	IEC 68-2-6

Testing Criteria	Classification
Mechanical shock	IEC 68-2-27
Random vibration	MIL-STD-810D

## Faceplate Chemical Resistance

The system's faceplate can resist the chemicals listed below, with no visible effect.

Acetone	Sulfuric Acid 10%	Motor oil
MEK	Hydrochloric Acid 10%	Gasoline
Toluene	Acetic Acid 10%	Machine oil
Methylene Chloride	Phosphoric Acid	Salad oil
Isopropyl Alcohol	Sodium Hydroxide 10%	Silicone
Xylene	Carbon Tetrachloride	Silicone grease G31
Hexane	Potassium Hydroxide	Kerosene
Butyl Cellosolve	Ammonia water 10%	Gas oil
Cyclohexanone	Sodium Chloride 26%	Silicone oil
Trichloroethylene	Zinc Chloride 81%	Engine oil
Ethanol	Cottonseed oil	Cleanser
Methanol	Glycerin	
Nitric Acid 10%	Grease	

All system surfaces exposed outside of an enclosure are resistive to the following chemicals:

- Commercial glass cleaners
- Ammonia (10% dilute solution)
- Motor oil
- Hydraulic fluid
- Diesel fuel
- Gasoline (leaded, unleaded)
- Silicone-based lubricant
- Alcohol (ethyl, methyl)
- Automatic transmission fluid



### Important

Sustained exposure to brake fluid or Gunk® brand degreaser can cause damage to monitor materials.

## Agency Approvals

All models in the PS/PX/PC Series PowerStation are available with the following combinations of agency approvals:

Agency Approvals			
UL	CUL		
UL	CUL	CE	
UL	CUL	Class 1 Div 2	
UL	CUL	CE	Class 1 Div 2

# INDEX

A	
Adapter cards,.....	83
Adding Expansion Cards, .....	83
Agency Approvals, .....	111
Application Engineering Services, .....	11
Autoexec.bat File	
Backup copy, .....	97
Step through, .....	96
Troubleshoot, .....	97
B	
Backlight bulbs, .....	76
Battery, .....	31
Field Replaceable, .....	76
Lithium, .....	31
BIOS, .....	19
Displays Supported, .....	20
Features	
Standard Model, .....	19, 105
Memory Map, .....	37
Settings, .....	50
Default, .....	56
Bus interfaces, .....	17
C	
CD-ROM, .....	24
Access, .....	41
Field Replaceable, .....	76
Location, .....	22
Specifications, .....	104
Use, .....	25
Vibration Rating, .....	108
Class I, Division 2 Guidelines, .....	40
Cleaning the Display Screen, .....	72
Closing the System, .....	81
CMOS settings, .....	88, 91
COM1, .....	27, 28, 36
COM2, .....	17, 27, 28, 36, 85, 87, 90
COM3, .....	27, 28, 36, 45
Compact Flash, .....	22, 104
Environmental Specifications, .....	108
Location, .....	22
Master/Slave, .....	87, 88, 90, 91
Jumpers, .....	85
Memory, .....	37
Reformat, .....	71
Remove, .....	24
Replace, .....	24
Use, .....	25
Using, .....	23
Config.sys File	
Backup copy, .....	97
Step through, .....	96
Troubleshoot, .....	97
Configurable jumpers, .....	17
Configuring Serial Ports, .....	51
Connecting the RS/RC Unit to a Monitor, ..	45
Copyright, .....	2
CPU, .....	27, 34, 36, 98
Battery, .....	31
CF Location, .....	22
Characteristics, .....	17
Diagram, .....	18, 19
Jumpers, .....	86, 89
Features, .....	13
Fuse, .....	32
Voltage, .....	31
Watchdog Timer, .....	32
Customer Support, .....	9
Consulting Services, .....	11
Product Support Program, .....	11
Training, .....	10
D	
Displays, .....	21
BIOS Support, .....	20
Function Keypad, .....	21
Problems, .....	94, 99
Specifications, .....	107
Video Port, .....	30
Drive Functions, .....	25
Drives, .....	22
Access, .....	41
CD-ROM, .....	24
CF, .....	22
Floppy, .....	24
Hard Drive, .....	24
E	
Electrical Guidelines, .....	40
Electrical Specifications, .....	109
Enclosure Guidelines, .....	41
Environmental Guidelines, .....	40
Environmental Specifications, .....	108
EPROM, .....	19, 98, 105
ESD Precautions, .....	77
Ethernet	
Controller, .....	105



Ethernet Port, .....	26, 27, <b>30</b>	MS-DOS 6.22 and Utilities Installation Disk,	16
Jumpers, .....	85, 86, 89	Multiboot Systems, .....	46
Pinout Data, .....	30	N	
Specifications, .....	104	Null Modem, .....	28
Troubleshoot, .....	101	O	
Expansion Slots, .....	34, 105	Opening and Closing the System, .....	78
Max. Depth, .....	34	P	
Specifications, .....	109	Parallel Port, .....	20, 26, 29, 35, 36, 104
F		Pinout Data, .....	29
Faceplate, .....	40	Printer, .....	29
Chemical Resistance, .....	110	Peripheral Devices, .....	32, 100
FLASH memory, .....	19	Physical Specifications	
Floppy Drive, .....	24	Standard Model, .....	104
Field Replaceable, .....	76	Pinout Data	
Use, .....	25	Ethernet Port, .....	30
Function Keypad, .....	21	Parallel Port, .....	29
Operation, .....	21	PS/2 Ports, .....	30
Fuse, .....	32, 109	USB Ports, .....	31
Field Replaceable, .....	77	Video Port, .....	30
H		Power Supply, .....	31, 106
Hard Drive		PowerSmart, ....	32, 33, 34, 59, 67, 94, 97, 98, 106
Field Replaceable, .....	77	Screenshot, .....	32
Use, .....	25	Problems when starting, .....	94, 95
I		Problems with peripheral devices, .....	94
I/O addresses, .....	35, 101	Processor, .....	17
Industrial PC Drivers and Utilities CD, 16, 58, 68		Standard, .....	104
Interact, .....	21	PS/2 Ports, .....	26, 29, 104
Internal Temperatures		R	
PowerSmart, .....	32	RAM, .....	19, 94
IRQ		Recalibrating the Touchscreen, .....	74
Change, .....	36	Reconfiguring the Touchscreen Driver, .....	72
Choices, .....	105	Reconfiguring under Windows, .....	72
Recognition, .....	62	Reinstalling drivers, .....	68
Table, .....	36	Reinstalling MachineShop, .....	67
Touchscreen, .....	73, 85, 100	Reinstalling the MachineShop Shell, .....	70
ISO Symbols, .....	9	Replacement components, .....	77
J		Replacing Components, .....	76
Jumpers		Resetting Disk Boot Priority, .....	54
Change Settings, .....	85	Reverse Polarity Damage, .....	31
Diagram, .....	86, 89	RS-232, .....	27, 28, 87, 90, 104
M		RS-422, .....	27, 28, 87, 90
Memory, .....	36, 37, 84, 104	RS-485, .....	27, 28, 87, 90
Modules, .....	36	Runtime, .....	37
Mounting the System, .....	42	S	
MS-DOS, ...	16, 46, 47, 68, 69, 72, 75, 96, 106	SDRAM, .....	36, 37, 105, 106
PowerSmart, .....	33	Field Replaceable, .....	77
Reconfigure Touchscreen, .....	73	minimum recommended, .....	104
Restore on CF, .....	71		
Touchscreen, .....	74		

Selecting a Location, .....	40	Default Settings, .....	73
serial ports, .....	20, 51, 53, 87, 90	Recalibrate, .....	74
Serial Ports, .....	26, 27, 28, 52, 104	Training, .....	10
Standard Model		Troubleshooting, .....	10, 94
BIOS, .....	105	U	
Standards		USB Ports, .....	26, 31, 104
Documentation, .....	9	V	
ISO Symbols, .....	9	Video Port, .....	30, 104
System Parameters, .....	33	W	
T		Warranty, .....	2
Technical Support, .....	10	Watchdog Timer, .....	32, 35, 106
E-mail, .....	9	Weight, .....	104
Fax, .....	9	Win NT 4.0 Emergency Recovery Disk, ....	16, 58
Phone Number, .....	9	Windows 2000, .....	37, 58, 59, 63, 64, 106
Web, .....	9	Windows 98, .....	58, 59, 60, 66, 106
Temperature Guidelines, .....	41	Windows NT, .....	46, 58, 59, 60, 65, 66, 106
Testing Specifications, .....	109		
Touchscreen, .....	72, 75, 76, 77, 105		